

Catalogo prodotti

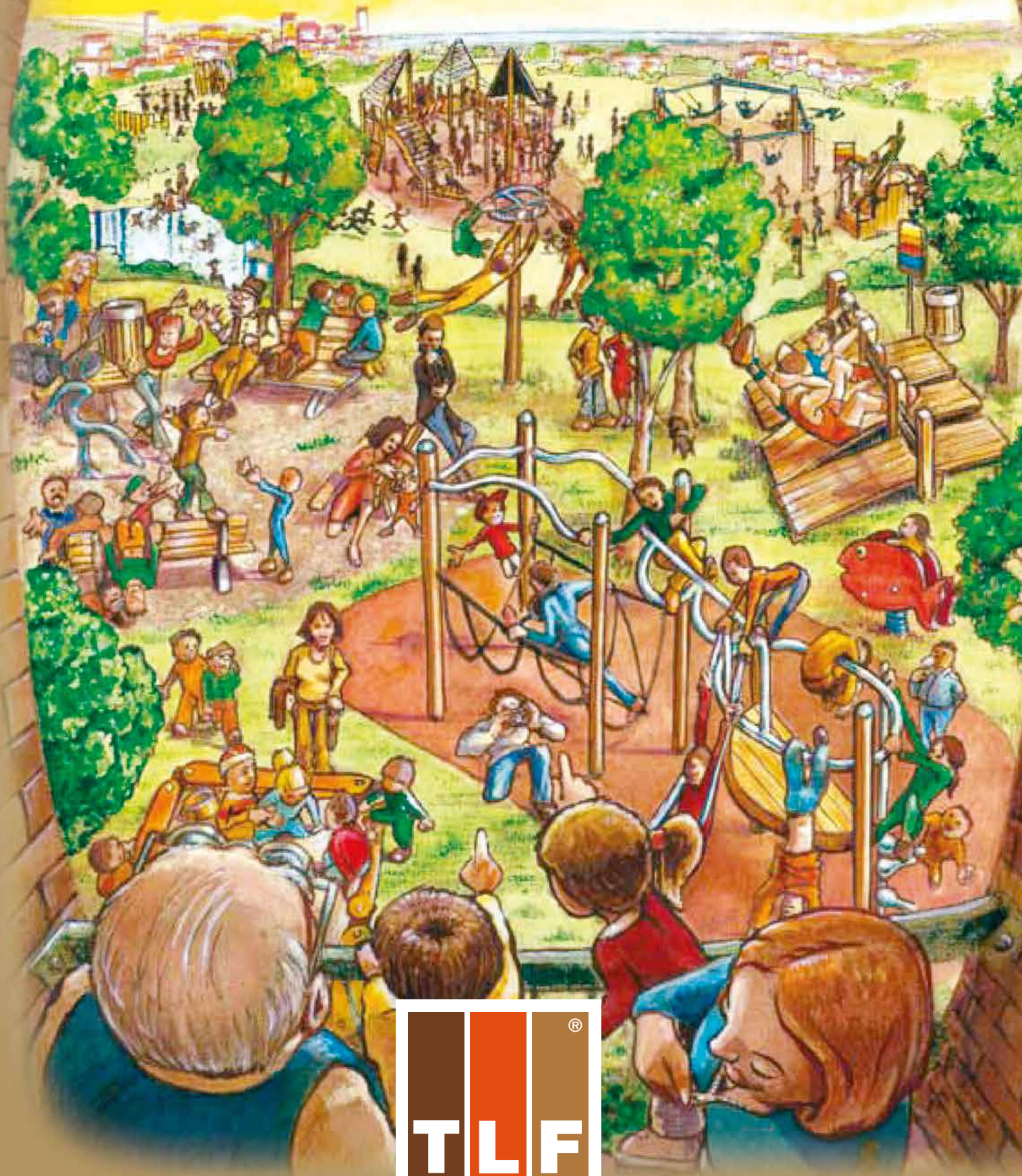





100% Made in Tuscany

**I prodotti TLF sono disegnati,
realizzati ed assemblati
in Toscana, Italia**

L'attività ludica

Scegliere gli articoli per i bambini

considerazioni sulle preferenze dei bambini di età diverse



1-3 ANNI

- esplora giocando (stare all'aria aperta è stimolante)
- una volta che ha imparato a camminare gli piace andare in giro e guardare tutto quello che c'è
- gli piace esercitarsi nei movimenti tipo salire le scale, saltellare, scivolare, dondolarsi e preferisce farlo senza essere troppo aiutato dagli adulti
- mantiene l'attenzione per periodi brevi
- ha tanti interessi
- preferisce una serie di piccole stazioni gioco inserite in un bel paesaggio
- ama giocare vicino agli adulti
- per mantenerne l'attenzione i giochi d'immaginazione devono essere supportati dall'ambiente

3-6 ANNI

- ama scoprire e sperimentare; ha grande curiosità per il mondo
- si diverte molto a manipolare materiali come la sabbia e l'acqua
- i giochi di socializzazione e di simulazione sono molto stimolanti
- spesso porta con sé nell'area gioco i propri giocattoli
- crea giochi d'immaginazione sofisticati se l'ambientazione lo permette
- apprezza molto le scenografie che stimolano la fantasia
- ama i giochi di movimento come arrampicarsi, dondolarsi, oscillare, correre e andare in bici
- ha bisogno di poter accedere alle "parti mobili" tipo costruzioni

6-10 ANNI

- giocare con gli amici diventa sempre più importante
- ricerca opportunità per giocare in gruppo
- continua ad apprezzare i materiali come sabbia e acqua, ma ora i giochi sono molto più complessi. Meglio mettergli a disposizione grandi superfici ricoperte di sabbia che sabbiere
- il gioco di socializzazione e d'immaginazione è molto sofisticato
- ha bisogno di molto spazio aperto per giochi con regole
- mantiene l'attenzione più a lungo e ama esercitarsi con le nuove capacità acquisite
- gli interessano le costruzioni, i giochi con regole e gli sport

9-12 ANNI

- a questa età le relazioni sono molto importanti, il valore dell'area gioco è rappresentato dallo stare insieme
- ogni gruppo cercherà di trovare il proprio spazio in cui giocare
- ha buona padronanza fisica e destrezza nella coordinazione, apprezza le sfide
- tende a giocare in gruppi omogenei ad eccezione dei giochi di socializzazione e di gruppo estesi a un ampio numero di partecipanti – ad esempio giochi di gruppo con la palla o giochi in cui rincorrersi
- cerca il rischio e l'entusiasmo
- non c'è bisogno di una grande struttura per attrarre un grande numero di bambini nell'area gioco, ma, piuttosto, di molti angoli nei quali piccoli gruppi possano giocare da sé

11-15 ANNI

- ama avere il proprio spazio e i propri oggetti di arredamento -l'area non deve avere l'aspetto e le caratteristiche di un'area per i più piccoli
- molto attivo e con sviluppata destrezza fisica; gli piace esibire quello che è in grado di fare
- preferisce luoghi non esposti allo sguardo dei genitori
- cerca la sfida e l'entusiasmo e nelle attività tende ad essere competitivo (chi è il più forte, ecc.)
- meglio se la zona per gli adolescenti non è adiacente all'area per i piccoli o in prossimità dell'abitato

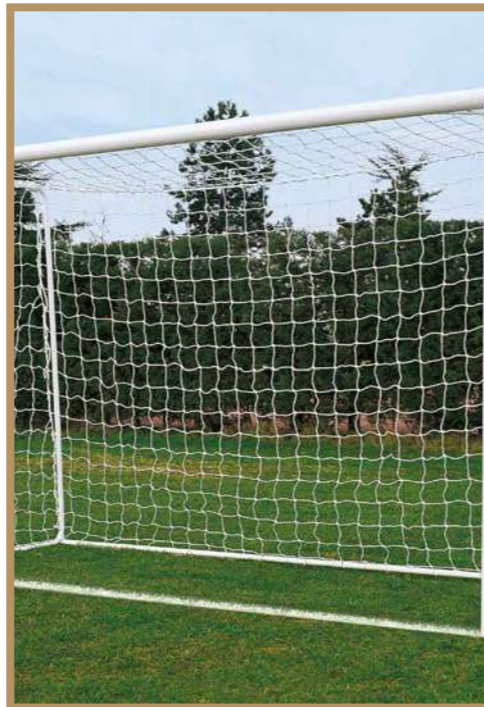

Informazioni ludiche

Spiegazione e definizione delle idee espresse in questo catalogo. Consigli utili per la progettazione di aree gioco

10



Yoko

Attrezzature ludiche a tema che stimolano la cooperazione, il gioco di movimento, immaginazione, esplorazione, giochi di ruolo ed esperienze sensoriali. Bambini nella fascia d'età 2 a 11 anni. Spazi pubblici non custoditi.

20



Togo

Attrezzature ludiche ricche di colore che stimolano il gioco di movimento, immaginazione, esplorazione, giochi di ruolo ed esperienze sensoriali. Bambini nella fascia d'età 1 a 8 anni. Spazi pubblici non custoditi.

38



Gardenia

Articoli e spazi ludici per attività di esplorazione, scoperta, primi approfondimenti scientifici, conoscenza della natura, giochi di ruolo e di socializzazione. Costituisce un sostegno nelle prime fasi della formazione da 0 a 11 anni. Aree custodite: scuole, centri per bambini, gruppi di gioco.

78



Modulo più

Un'ampia gamma di possibilità ludiche: gioco di movimento, socializzazione, gioco di ruolo e d'immaginazione, gioco con materiali sciolti. Strutture adatte allo sviluppo specifico di determinate fasi dell'infanzia, per bambini da 1 a 14 anni. Spazi pubblici non custoditi

140



Elastico

Ambienti ludici per il gioco attivo di movimento e di socializzazione per bambini dai 6 anni. Spazi pubblici non custoditi

188



Sporti

Complementi d'arredo, attrezzature e spazi per giochi organizzati secondo determinate regole e sport informali. Fascia d'età dai 6 anni. Aree pubbliche non custodite.

200



Policrosalus

Percorsi ginnici attrezzati per il fitness e il benessere.

204



Social Gym

Percorsi ginnici attrezzati per il fitness, accessibili e idonei anche per i disabili.

216



Active Point

Buone pratiche per promuovere la salute della comunità e favorire l'interazione tra le persone

230



GymCafe

Tendenze progettuali, suggerimenti e attrezzature dedicate agli utenti a quattro zampe e i loro compagni a due

232



Ninfeo

Arredare l'ambiente

236



Aluhabitat

La città è la casa di tutti

270

Spiegazione dei simboli usati in questo catalogo

Queste icone sono presenti in tutto il catalogo e stanno a indicare le attrezzature e/o gli arredi che riteniamo adatti a migliorare l'accessibilità e a stimolare il gioco integrato.



gioco accessibile

Gioco accessibile

Questa icona è utilizzata ogni qual volta si ritenga che un bambino su sedia a rotelle possa avvicinarsi o accedere all'attrezzatura ludica posta a terra, sempre che la superficie di accesso sia ben percorribile. Per le attività sui piani sopraelevati, il bambino, dopo aver lasciato la sedia a rotelle, può usufruire di ampi gradini o piattaforme, salire a gattoni o a saltelli. Inoltre, per alcuni articoli, possiamo fornire rampe di accesso su misura che permettono agli utenti su sedia a rotelle di utilizzare i piani sopraelevati.



gioco integrato

Gioco integrato

Con questo simbolo s'indicano le attrezzature dove i bambini affetti da disabilità più o meno gravi possono integrarsi con gli altri bambini. Questo non significa necessariamente che esse siano accessibili con la sedia a rotelle. Se l'accesso è ben percorribile, vale a dire che la superficie del terreno non presenta ostacoli e che la larghezza del percorso è sufficiente, i bambini che utilizzano la sedia a rotelle o altri mezzi per sostenere la propria deambulazione, possono avvicinarsi e accedere alle strutture ludiche senza avere bisogno di questi.



area gioco custodita

Area gioco custodita

Si tratta di un'area custodita da adulti che controllano l'attività ludica e in qualche caso di parchi pubblici chiusi di sera e di notte.

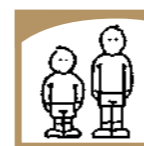

età d'uso

L'età consigliata

E' importante che le dimensioni delle strutture ludiche siano adeguate alla corporatura dei bambini, come pure alle loro diverse abilità e interessi. Le età consigliate per gli utenti sono appositamente predisposte a questo scopo.



area d'impatto > 60 cm

Area di caduta adeguata

Le aree di caduta, laddove siano necessarie, sono di dimensioni sufficienti? Vedi le raccomandazioni relative ad area di caduta/superficie ad assorbimento di impatto allegata alle schede tecniche di prodotto.



altezza di caduta libera in cm

Altezza di caduta

Si riferisce al punto più alto accessibile del gioco da cui si può cadere. L'altezza di caduta è misurata in centimetri.



spazio minimo

Lo spazio minimo

Lo spazio minimo dovrebbe essere libero da oggetti che presentino particolare durezza o asperità.



dimensioni in cm

Dimensioni

Si riferisce all'ingombro massimo della struttura (b x l x h) misurata in centimetri.



mattonelle in gomma

Mattonelle in gomma

Misura in m² la superficie intorno alla struttura che deve essere protetta con una pavimentazione antitrauma adeguata.



numero e dimensione dei plinti

Plinti

Numero e dimensione dei plinti.



numero d'installatori

Numero d'installatori

Si riferisce al personale necessario per l'installazione del gioco.



quantità di cemento

Quantità di cemento

Metri cubi di cemento necessari per fissare i plinti del gioco nel terreno.



tempo d'assemblaggio

Tempo d'assemblaggio

È il tempo minimo necessario per effettuare il montaggio dell'attrezzatura.



Consigli per la realizzazione di un buon ambiente **gioco**

TLF è consapevole che gli ambienti riservati al gioco dei bambini devono offrire, oltre alla sicurezza prevista dalla normativa di riferimento, un adeguato livello di divertimento e di sfida. Un'area gioco completa e sicura è quella che propone una varietà di modi di giocare in un contesto piacevole e ben curato.

Se è necessario prestare la massima attenzione alla selezione delle attrezzature ludiche, ancora più importante è lo studio della loro dislocazione

Ad esempio i giochi di manipolazione per la prima infanzia, quelli di socializzazione e drammatizzazione dovrebbero essere posizionati in prossimità dei luoghi di incontro degli adulti, mentre i giochi di movimento per i bambini in età scolare dovrebbero essere dislocati lontano dai punti riservati agli adulti ed ai più piccoli.

Tutti fuori!

Persone di diverse abilità e interessi trovano piacevole stare all'aria aperta. Chi non si sente bene trova grande beneficio nel contatto con la natura ed è comprovato che stare all'aperto in un contesto naturale può rendere più veloce la guarigione.

Pertanto, nel processo di creazione di spazi per la vita all'aria aperta, è necessario prendere in considerazione le esigenze di tutti: è indispensabile ad esempio assicurarsi che coloro che hanno problemi di mobilità siano in grado di accedere e trarre giovamento dall'utilizzo di queste aree.

Gli anziani e le persone più fragili devono avere la possibilità di passare ore piacevoli all'aperto godendo degli ampi spazi, della natura e del sole, osservando la vita della comunità.



Vita all'aperto per tutti

La più ampia gamma di articoli per gioco inclusivo e accessibile

TLF dispone di una serie estremamente vasta di articoli per il gioco inclusivo, che permettono la creazione di aree gioco adeguate ad utenti con esigenze specifiche o che tengono conto di coloro che possono trarre beneficio da certe modalità di gioco o da particolari ambientazioni ludiche più ombreggiate o meglio protette dall'azione del vento.

Gioco inclusivo significa che persone di tutte le abilità e interessi possono giocare nella stessa area e possibilmente lo faranno insieme. Un tipo di inclusione si ottiene creando aree dove bambini con disabilità e limitate capacità motorie possano divertirsi con una vasta serie di opportunità ludiche. Un'altra forma di gioco inclusivo è quella di assicurarsi che i genitori ed i nonni con limitate capacità motorie possano accedere all'area gioco con i loro bambini e passare il tempo in allegria.

Le nostre altalene sono fatte per tutti i bambini

I bambini con limitate capacità motorie utilizzano la sedia a rotelle come strumento indispensabile per muoversi, ma non la trovano molto piacevole: quando arrivano all'area gioco desiderano, per quanto possibile, giocare come tutti gli altri. I bambini traggono beneficio da esperienze ludiche come andare in altalena, se possono usare la propria muscolatura in modo da influire sul movimento, cosa impossibile stando seduti su una sedia a rotelle. Gli esperti di gioco inclusivo per bambini, fanno notare che le altalene che fungono da culla per il bambino che necessita di maggior sostegno o che permettono ad un ragazzo più grande o ad un adulto di tenerlo in braccio, hanno effetti molto più positivi, oltre a costituire una piacevole esperienza per il disabile.

Giocare tutti insieme è più divertente, gioco inclusivo significa gioco per tutti



TLF porta ovunque il vivere italiano



TLF, leader per la produzione di parchi giochi, percorsi ginnici e arredo urbano, è il marchio che grazie alla sua rete commerciale, porta nel mondo “l’italian style”.

TLF, da sempre sensibile e precorritrice di soluzioni innovative per la salvaguardia e tutela dell’ambiente, utilizza un innovativo processo di recupero degli scarti di lavorazione che tramite un impianto di stoccaggio e produzione calore da 2,5 mil. Kcal/h, permette di gestire in autonomia il complesso ciclo di impregnazione ed essiccazione del legname che proviene da “filiera corta” e da foreste certificate **FSC®** (Forest Stewardship Council®).

Tale risultato, che si aggiunge alla qualità, affidabilità e durabilità degli articoli a marchio TLF attestata dalle più importanti certificazioni di processo (**ISO 9001 - sistema di gestione della**

qualità) e prodotto (**TÜV-Sud**), fanno di TLF un’azienda all’avanguardia nell’adozione di metodologie ed impianti che possono garantire nel tempo il massimo rispetto dell’ambiente avendo anche ottenuto la certificazione **ISO 14001** in materia di ambiente e gestione dei rifiuti.

Inoltre, in previsione dell’entrata in vigore del decreto 7 febbraio 2023 in tema di “**Criteri Ambientali Minimi-CAM**”, TLF ha da tempo provveduto ad adeguare l’intero processo produttivo alla nuova normativa tanto è vero che già oltre 300 articoli prodotti hanno ottenuto la piena certificazione CAM rilasciata da ente indipendente.

La nuova struttura produttiva TLF è stata realizzata interamente in Bioedilizia utilizzando maestranze interne su progetto dell’Ingegnere e professore emerito Julius Natterer

Con l'attivazione del nuovissimo impianto fotovoltaico ibrido, TLF è divenuta autonoma anche in materia energetica rendendo così l'intero ciclo produttivo completamente ecosostenibile rinunciando pertanto all'energia prodotta dall'estrazione da fonti fossili.

Procedure TLF di collaudo

Tutta l'attrezzatura per le aree gioco presentata in questo catalogo è stata progettata e realizzata prestando molta attenzione alla sicurezza ed al valore ludico. Tutti gli articoli hanno superato i test di conformità all'EN1176 e sono stati certificati dal Technical Testing Institute (TÜV). Ove la superficie protettiva sia necessaria, le dimensioni "dell'area d'impatto" sono indicate per ciascun articolo essendo necessario prevedere la buona accessibilità alle strutture e la libertà di movimento attorno ad esse.

Certificati aziendali



ISO 9001:2015, sistema di gestione della qualità dei processi aziendali.



Il *Forest Stewardship Council*® (**FSC**®) è un'organizzazione globale senza fini di lucro dedicata alla promozione della gestione responsabile delle foreste del mondo. Richiedi i nostri prodotti certificati FSC®



ISO 14001:2015, sistema di gestione finalizzato a ridurre al minimo l'impatto negativo dell'attività aziendale sull'ambiente.



CAM: certificato che individua prodotti che rispondono ai Criteri Ambientali Minimi.



TÜV SÜD PRODUCT SERVICE
Certificazione della rispondenza dei prodotti TLF a norma **UNI EN 1176**



Rating di legalità: strumento volto alla promozione e all'introduzione di principi di comportamento etico in ambito aziendale.



TLF

servizi e affidabilità

La nostra azienda ha due clienti: il primo è il professionista acquirente delle attrezzature per spazi all'aria aperta (che non usa le attrezzature) e il secondo: i bambini e tutti i residenti della zona che utilizzano gli spazi pubblici.

Affidabilità

Ci siamo prefissi lo scopo di essere un partner professionale ed affidabile nel settore della progettazione e gestione di spazi pubblici per la vita all'aria aperta. Il nostro sistema di gestione aziendale si avvale dei più moderni metodi e strumenti per quanto attiene ai temi della qualità e dell'ambiente. Per la realizzazione dei nostri prodotti impieghiamo inoltre metodi lavorativi molto tecnologici ed innovativi.

Rendere un servizio alla comunità

TLF si serve di consulenti che incontrano gli acquirenti professionisti per informarli sull'azienda e sui servizi offerti. Riteniamo, infatti, che questo sia il modo migliore per assicurarci che i nostri clienti siano in possesso di tutte le nozioni necessarie per scegliere in modo informato, stando dalla parte dell'utente finale. Il programma di formazione continua e sviluppo personale rivolto a tutti i membri del nostro staff ed ai nostri consociati, li tiene sempre aggiornati su tutti gli

aspetti collegati ad una buona progettazione e realizzazione di spazi per la vita all'aria aperta.

Conformità agli standard

La conformità agli standard e il nostro impegno a lavorare nel rispetto di tutte le normative, leggi e requisiti specifici nei settori della sostenibilità ambientale, sono indicativi del nostro sistema di progettazione a lungo termine, che ci permette di essere un'azienda stabile e produttiva, sulla quale potrete contare come partner esperto nella realizzazione di spazi per la vita all'aperto. Il nostro impegno per un continuo miglioramento dimostra che comprendiamo come questo sia un valore necessario alla continuità di un'azienda nel lungo periodo.

Servizi

- Consulenza per la progettazione
- Seminari di formazione
- Manutenzione
- Design personalizzato



CATENA

50





100% Made in Tuscany

**I prodotti TLF sono disegnati,
realizzati ed assemblati
in Toscana, Italia**

L'attività ludica

Scegliere gli articoli per i bambini
considerazioni sulle preferenze dei bambini di età diverse



1-3 ANNI

- esplora giocando (stare all'aria aperta è stimolante)
- una volta che ha imparato a camminare gli piace andare in giro e guardare tutto quello che c'è
- gli piace esercitarsi nei movimenti tipo salire le scale, saltellare, scivolare, dondolarsi e preferisce farlo senza essere troppo aiutato dagli adulti
- mantiene l'attenzione per periodi brevi
- ha tanti interessi
- preferisce una serie di piccole stazioni gioco inserite in un bel paesaggio
- ama giocare vicino agli adulti
- per mantenerne l'attenzione i giochi d'immaginazione devono essere supportati dall'ambiente

3-6 ANNI

- ama scoprire e sperimentare; ha grande curiosità per il mondo
- si diverte molto a manipolare materiali come la sabbia e l'acqua
- i giochi di socializzazione e di simulazione sono molto stimolanti
- spesso porta con sé nell'area gioco i propri giocattoli
- crea giochi d'immaginazione sofisticati se l'ambientazione lo permette
- apprezza molto le scenografie che stimolano la fantasia
- ama i giochi di movimento come arrampicarsi, dondolarsi, oscillare, correre e andare in bici
- ha bisogno di poter accedere alle "parti mobili" tipo costruzioni

6-10 ANNI

- giocare con gli amici diventa sempre più importante
- ricerca opportunità per giocare in gruppo
- continua ad apprezzare i materiali come sabbia e acqua, ma ora i giochi sono molto più complessi. Meglio mettergli a disposizione grandi superfici ricoperte di sabbia che sabbiere
- il gioco di socializzazione e d'immaginazione è molto sofisticato
- ha bisogno di molto spazio aperto per giochi con regole
- mantiene l'attenzione più a lungo e ama esercitarsi con le nuove capacità acquisite
- gli interessano le costruzioni, i giochi con regole e gli sport

9-12 ANNI

- a questa età le relazioni sono molto importanti, il valore dell'area gioco è rappresentato dallo stare insieme
- ogni gruppo cercherà di trovare il proprio spazio in cui giocare
- ha buona padronanza fisica e destrezza nella coordinazione, apprezza le sfide
- tende a giocare in gruppi omogenei ad eccezione dei giochi di socializzazione e di gruppo estesi a un ampio numero di partecipanti – ad esempio giochi di gruppo con la palla o giochi in cui rincorrersi
- cerca il rischio e l'entusiasmo
- non c'è bisogno di una grande struttura per attrarre un grande numero di bambini nell'area gioco, ma, piuttosto, di molti angoli nei quali piccoli gruppi possano giocare da sé

11-15 ANNI

- ama avere il proprio spazio e i propri oggetti di arredamento -l'area non deve avere l'aspetto e le caratteristiche di un'area per i più piccoli
- molto attivo e con sviluppata destrezza fisica; gli piace esibire quello che è in grado di fare
- preferisce luoghi non esposti allo sguardo dei genitori
- cerca la sfida e l'entusiasmo e nelle attività tende ad essere competitivo (chi è il più forte, ecc.)
- meglio se la zona per gli adolescenti non è adiacente all'area per i piccoli o in prossimità dell'abitato

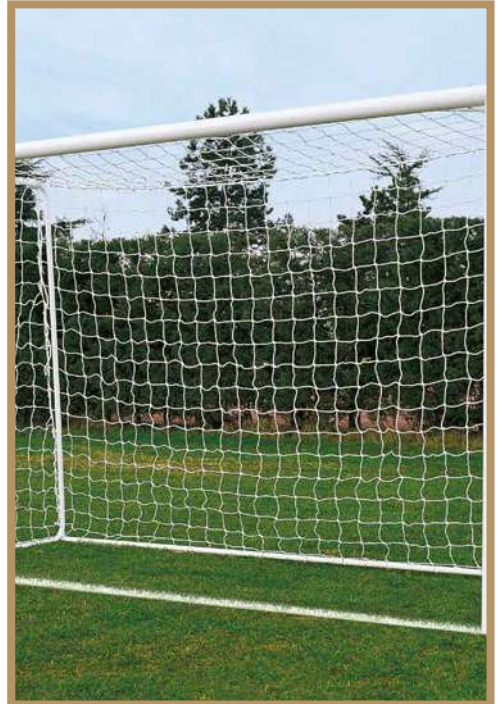

	Informazioni ludiche Spiegazione e definizione delle idee espresse in questo catalogo. Consigli utili per la progettazione di aree gioco	10
	Yoko Attrezzature ludiche a tema che stimolano la cooperazione, il gioco di movimento, immaginazione, esplorazione, giochi di ruolo ed esperienze sensoriali. Bambini nella fascia d'età 2 a 11 anni. Spazi pubblici non custoditi.	20
	Togo Attrezzature ludiche ricche di colore che stimolano il gioco di movimento, immaginazione, esplorazione, giochi di ruolo ed esperienze sensoriali. Bambini nella fascia d'età 1 a 8 anni. Spazi pubblici non custoditi.	38
	Gardenia Articoli e spazi ludici per attività di esplorazione, scoperta, primi approfondimenti scientifici, conoscenza della natura, giochi di ruolo e di socializzazione. Costituisce un sostegno nelle prime fasi della formazione da 0 a 11 anni. Aree custodite: scuole, centri per bambini, gruppi di gioco.	78
	Modulo più Un'ampia gamma di possibilità ludiche: gioco di movimento, socializzazione, gioco di ruolo e d'immaginazione, gioco con materiali sciolti. Strutture adatte allo sviluppo specifico di determinate fasi dell'infanzia, per bambini da 1 a 14 anni. Spazi pubblici non custoditi	140
	Elastico Ambienti ludici per il gioco attivo di movimento e di socializzazione per bambini dai 6 anni. Spazi pubblici non custoditi	188
	Sporti Complementi d'arredo, attrezzature e spazi per giochi organizzati secondo determinate regole e sport informali. Fascia d'età dai 6 anni. Aree pubbliche non custodite.	200
	Policrosalus Percorsi ginnici attrezzati per il fitness e il benessere.	204
	Social Gym Percorsi ginnici attrezzati per il fitness, accessibili e idonei anche per i disabili.	216
	Active Point Buone pratiche per promuovere la salute della comunità e favorire l'interazione tra le persone	230
	Gymcane Tendenze progettuali, suggerimenti e attrezzature dedicate agli utenti a quattro zampe e i loro compagni a due	232
	Ninfeo Arredare l'ambiente	236
	Aluhabitat La città è la casa di tutti	270

Spiegazione dei **simboli** usati in questo catalogo

Queste icone sono presenti in tutto il catalogo e stanno a indicare le attrezzature e/o gli arredi che riteniamo adatti a migliorare l'accessibilità e a stimolare il gioco integrato.



gioco accessibile

Gioco accessibile

Questa icona è utilizzata ogni qual volta si ritenga che un bambino su sedia a rotelle possa avvicinarsi o accedere all'attrezzatura ludica posta a terra, sempre che la superficie di accesso sia ben percorribile. Per le attività sui piani sopraelevati, il bambino, dopo aver lasciato la sedia a rotelle, può usufruire di ampi gradini o piattaforme, salire a gattoni o a saltelli. Inoltre, per alcuni articoli, possiamo fornire rampe di accesso su misura che permettono agli utenti su sedia a rotelle di utilizzare i piani sopraelevati.



gioco integrato

Gioco integrato

Con questo simbolo s'indicano le attrezzature dove i bambini affetti da disabilità più o meno gravi possono integrarsi con gli altri bambini. Questo non significa necessariamente che esse siano accessibili con la sedia a rotelle. Se l'accesso è ben percorribile, vale a dire che la superficie del terreno non presenta ostacoli e che la larghezza del percorso è sufficiente, i bambini che utilizzano la sedia a rotelle o altri mezzi per sostenere la propria deambulazione, possono avvicinarsi e accedere alle strutture ludiche senza avere bisogno di questi.



area gioco custodita

Area gioco custodita

Si tratta di un'area custodita da adulti che controllano l'attività ludica e in qualche caso di parchi pubblici chiusi di sera e di notte.

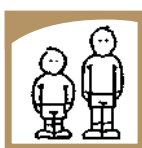

età d'uso

L'età consigliata

E' importante che le dimensioni delle strutture ludiche siano adeguate alla corporatura dei bambini, come pure alle loro diverse abilità e interessi. Le età consigliate per gli utenti sono appositamente predisposte a questo scopo.

area d'impatto
> 60 cm

Area di caduta adeguata

Le aree di caduta, laddove siano necessarie, sono di dimensioni sufficienti? Vedi le raccomandazioni relative ad area di caduta/superficie ad assorbimento di impatto allegata alle schede tecniche di prodotto.

altezza di caduta
libera in cm

Altezza di caduta

Si riferisce al punto più alto accessibile del gioco da cui si può cadere. L'altezza di caduta è misurata in centimetri.



spazio minimo

Lo spazio minimo

Lo spazio minimo dovrebbe essere libero da oggetti che presentino particolare durezza o asperità.



dimensioni in cm

Dimensioni

Si riferisce all'ingombro massimo della struttura (b×l×h) misurata in centimetri.

mattonelle
in gomma

Mattonelle in gomma

Misura in m² la superficie intorno alla struttura che deve essere protetta con una pavimentazione antitrauma adeguata.

numero e
dimensione dei plinti

Plinti

Numero e dimensione dei plinti.



numero d'installatori

Numero d'installatori

Si riferisce al personale necessario per l'installazione del gioco.



quantità di cemento

Quantità di cemento

Metri cubi di cemento necessari per fissare i plinti del gioco nel terreno.



tempo d'assemblaggio

Tempo d'assemblaggio

È il tempo minimo necessario per effettuare il montaggio dell'attrezzatura.



**Consigli per la realizzazione
di un buon
ambiente gioco**



TLF è consapevole che gli ambienti riservati al gioco dei bambini devono offrire, oltre alla sicurezza prevista dalla normativa di riferimento, un adeguato livello di divertimento e di sfida. Un'area gioco completa e sicura è quella che propone una varietà di modi di giocare in un contesto piacevole e ben curato.

Se è necessario prestare la massima attenzione alla selezione delle attrezzature ludiche, ancora più importante è lo studio della loro dislocazione

Ad esempio i giochi di manipolazione per la prima infanzia, quelli di socializzazione e drammatizzazione dovrebbero essere posizionati in prossimità dei luoghi di incontro degli adulti, mentre i giochi di movimento per i bambini in età scolare dovrebbero essere dislocati lontano dai punti riservati agli adulti ed ai più piccoli.

Tutti fuori!

Persone di diverse abilità e interessi trovano piacevole stare all'aria aperta. Chi non si sente bene trova grande beneficio nel contatto con la natura ed è comprovato che stare all'aperto in un contesto naturale può rendere più veloce la guarigione.

Pertanto, nel processo di creazione di spazi per la vita all'aria aperta, è necessario prendere in considerazione le esigenze di tutti: è indispensabile ad esempio assicurarsi che coloro che hanno problemi di mobilità siano in grado di accedere e trarre giovamento dall'utilizzo di queste aree.

Gli anziani e le persone più fragili devono avere la possibilità di passare ore piacevoli all'aperto godendo degli ampi spazi, della natura e del sole, osservando la vita della comunità.





Vita all'aperto per tutti

La più ampia gamma di articoli per gioco inclusivo e accessibile

TLF dispone di una serie estremamente vasta di articoli per il gioco inclusivo, che permettono la creazione di aree gioco adeguate ad utenti con esigenze specifiche o che tengono conto di coloro che possono trarre beneficio da certe modalità di gioco o da particolari ambientazioni ludiche più ombreggiate o meglio protette dall'azione del vento.

Gioco inclusivo significa che persone di tutte le abilità e interessi possono giocare nella stessa area e possibilmente lo faranno insieme. Un tipo di inclusione si ottiene creando aree dove bambini con disabilità e limitate capacità motorie possano divertirsi con una vasta serie di opportunità ludiche. Un'altra forma di gioco inclusivo è quella di assicurarsi che i genitori ed i nonni con limitate capacità motorie possano accedere all'area gioco con i loro bambini e passare il tempo in allegria.

Le nostre altalene sono fatte per tutti i bambini

I bambini con limitate capacità motorie utilizzano la sedia a rotelle come strumento indispensabile per muoversi, ma non la trovano molto piacevole: quando arrivano all'area gioco desiderano, per quanto possibile, giocare come tutti gli altri. I bambini traggono beneficio da esperienze ludiche come andare in altalena, se possono usare la propria muscolatura in modo da influire sul movimento, cosa impossibile stando seduti su una sedia a rotelle. Gli esperti di gioco inclusivo per bambini, fanno notare che le altalene che fungono da culla per il bambino che necessita di maggior sostegno o che permettono ad un ragazzo più grande o ad un adulto di tenerlo in braccio, hanno effetti molto più positivi, oltre a costituire una piacevole esperienza per il disabile.

Giocare tutti insieme è più divertente, gioco inclusivo significa gioco per tutti

TLF porta ovunque il

vivere italiano



TLF, leader per la produzione di parchi giochi, percorsi ginnici e arredo urbano, è il marchio che grazie alla sua rete commerciale, porta nel mondo “l’italian style”.

TLF, da sempre sensibile e precorritrice di soluzioni innovative per la salvaguardia e tutela dell’ambiente, utilizza un innovativo processo di recupero degli scarti di lavorazione che tramite un impianto di stoccaggio e produzione calore da 2,5 mil. Kcal/h, permette di gestire in autonomia il complesso ciclo di impregnazione ed essiccazione del legname che proviene da “filiera corta” e da foreste certificate **FSC®** (*Forest Stewardship Council®*).

Tale risultato, che si aggiunge alla qualità, affidabilità e durabilità degli articoli a marchio TLF attestata dalle più importanti certificazioni di processo (**ISO 9001 - sistema di gestione della**

qualità) e prodotto (**TÜV-Sud**), fanno di TLF un’azienda all’avanguardia nell’adozione di metodologie ed impianti che possono garantire nel tempo il massimo rispetto dell’ambiente avendo anche ottenuto la certificazione **ISO 14001** in materia di ambiente e gestione dei rifiuti.

Inoltre, in previsione dell’entrata in vigore del decreto 7 febbraio 2023 in tema di “**Criteri Ambientali Minimi-CAM**”, TLF ha da tempo provveduto ad adeguare l’intero processo produttivo alla nuova normativa tanto è vero che già oltre 300 articoli prodotti hanno ottenuto la piena certificazione CAM rilasciata da ente indipendente.

La nuova struttura produttiva TLF è stata realizzata interamente in Bioedilizia utilizzando maestranze interne su progetto dell’Ingegnere e professore emerito Julius Natterer

Con l'attivazione del nuovissimo impianto fotovoltaico ibrido, TLF è divenuta autonoma anche in materia energetica rendendo così l'intero ciclo produttivo completamente ecosostenibile rinunciando pertanto all'energia prodotta dall'estrazione da fonti fossili.



Procedure TLF di collaudo

Tutta l'attrezzatura per le aree gioco presentata in questo catalogo è stata progettata e realizzata prestando molta attenzione alla sicurezza ed al valore ludico. Tutti gli articoli hanno superato i test di conformità all'EN1176 e sono stati certificati dal Technical Testing Institute (TÜV). Ove la superficie protettiva sia necessaria, le dimensioni "dell'area d'impatto" sono indicate per ciascun articolo essendo necessario prevedere la buona accessibilità alle strutture e la libertà di movimento attorno ad esse.

Certificati aziendali



ISO 9001:2015, sistema di gestione della qualità dei processi aziendali.



Il *Forest Stewardship Council® (FSC®)* è un'organizzazione globale senza fini di lucro dedicata alla promozione della gestione responsabile delle foreste del mondo. Richiedi i nostri prodotti certificati FSC®



ISO 14001:2015, sistema di gestione finalizzato a ridurre al minimo l'impatto negativo dell'attività aziendale sull'ambiente.



CAM: certificato che individua prodotti che rispondono ai Criteri Ambientali Minimi.



TÜV SÜD PRODUCT SERVICE
Certificazione della rispondenza dei prodotti TLF a norma **UNI EN 1176**



Rating di legalità: strumento volto alla promozione e all'introduzione di principi di comportamento etico in ambito aziendale.



TLF

servizi e affidabilità

La nostra azienda ha due clienti: il primo è il professionista acquirente delle attrezzature per spazi all'aria aperta (che non usa le attrezzature) e il secondo: i bambini e tutti i residenti della zona che utilizzano gli spazi pubblici.

Affidabilità

Ci siamo prefissi lo scopo di essere un partner professionale ed affidabile nel settore della progettazione e gestione di spazi pubblici per la vita all'aria aperta. Il nostro sistema di gestione aziendale si avvale dei più moderni metodi e strumenti per quanto attiene ai temi della qualità e dell'ambiente. Per la realizzazione dei nostri prodotti impieghiamo inoltre metodi lavorativi molto tecnologici ed innovativi.

Rendere un servizio alla comunità

TLF si serve di consulenti che incontrano gli acquirenti professionisti per informarli sull'azienda e sui servizi offerti. Riteniamo, infatti, che questo sia il modo migliore per assicurarci che i nostri clienti siano in possesso di tutte le nozioni necessarie per scegliere in modo informato, stando dalla parte dell'utente finale. Il programma di formazione continua e sviluppo personale rivolto a tutti i membri del nostro staff ed ai nostri consociati, li tiene sempre aggiornati su tutti gli

aspetti collegati ad una buona progettazione e realizzazione di spazi per la vita all'aria aperta.

Conformità agli standard

La conformità agli standard e il nostro impegno a lavorare nel rispetto di tutte le normative, leggi e requisiti specifici nei settori della sostenibilità ambientale, sono indicativi del nostro sistema di progettazione a lungo termine, che ci permette di essere un'azienda stabile e produttiva, sulla quale potrete contare come partner esperto nella realizzazione di spazi per la vita all'aperto. Il nostro impegno per un continuo miglioramento dimostra che comprendiamo come questo sia un valore necessario alla continuità di un'azienda nel lungo periodo.

Servizi

- Consulenza per la progettazione
- Seminari di formazione
- Manutenzione
- Design personalizzato



YOKO
+ PLAY X KIDS

per bambini fino **11**anni

Yoko è la linea di TLF progettata per offrire la possibilità di introdurre articoli a tema e accessibili nel contesto di aree gioco all'aperto. Il design è stato pensato per essere combinato in spazi ludici vari e stimolanti, che riflettono gli interessi e le necessità di tutti gli utenti.

ambienti che favoriscono il gioco attivo

Per bambini e adulti, il gioco rafforza la mente e il corpo, indirizzando il percorso verso la competenza sociale, la stabilità emotiva, la capacità fisica e il successo.

Ad esempio, se un bambino cerca attivamente e abitualmente l'interazione con altri bambini, dovremmo incoraggiare quel bambino a socializzare. Analogamente è importante rispettare gli spazi dove i bambini possono giocare in solitario lasciando che seguano la propria curiosità.

Gioco e movimento

La nuova linea **Yoko** è il risultato degli studi condotti da TLF nell'ambito del gioco infantile all'aperto e delle sue interrelazioni con l'ambiente circostante.

Tramite la progettazione è importante costruire ambienti che favoriscono il gioco, in quanto il gioco è movimento.

Il gioco di movimento attiva il cervello e favorisce l'apprendimento, l'innovazione, la flessibilità, l'adattabilità e la resilienza. Il movimento struttura la nostra conoscenza del mondo, dello spazio, del tempo e del nostro rapporto con gli altri.

Soluzioni di inclusione

La chiave per coltivare efficacemente il potenziale di tutte le persone in gioco dipende dall'inclusione.

Per realizzare uno spazio inclusivo in TLF, abbiamo condotto una attenta ricerca volta a progettare prodotti dalle molteplici funzionalità.

Yoko offre una gamma più ampia di attività diverse e stimolanti, dove il livello di sfida è alla portata di tutti, creando spazi d'aggregazione.



Grazie all'esperienze di gioco i bambini hanno la possibilità di acquisire conoscenze sensoriali aumentando la loro comprensione del mondo

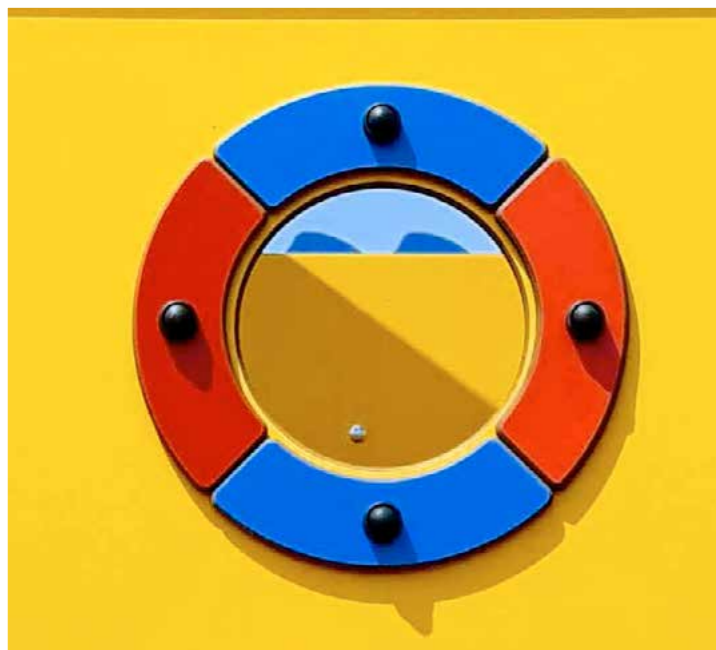

Offrire ai bambini numerosi strumenti per il corretto sviluppo delle loro capacità cognitive



Incoraggiare la creatività e l'immaginazione dei bambini, trasformando i parchi giochi in una vera e propria avventura

I montanti delle strutture sono in alluminio e acciaio inox per aumentare la resistenza nel tempo nei prodotti utilizzati

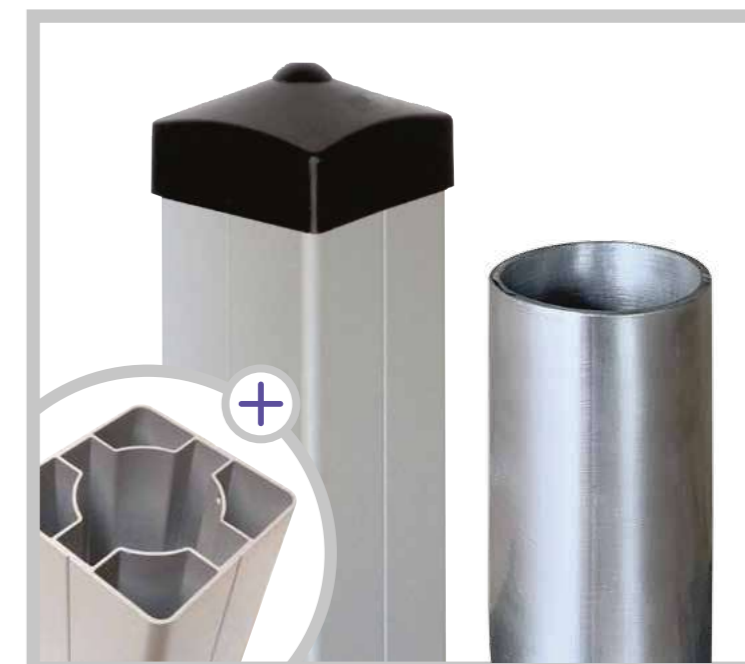

I pannelli e le sponde degli scivoli sono in HPL di 14 mm di spessore. Un materiale di grande resistenza al graffio e agli agenti atmosferici



Le pedane dei piani e delle scale sono realizzate in HPL con superficie ruvida per conferire un adeguato grip in qualsiasi condizione





YOKO

+ PLAY X KIDS

YOKO

YOKO MARINA

La combinazione tra gioco libero, gioco guidato e gioco semplificato è molto importante per lo sviluppo dei bambini. Le attività di gioco inclusivo non sono progettate per sostituire il gioco libero, ma offrono molte opportunità per promuovere lo sviluppo del carattere nell'ambito della creazione di un ambiente accessibile. Ciascuna attività mira a proporre divertenti opportunità di gioco con lo scopo di creare conoscenza, di eliminare le barriere e di favorire l'amicizia tra bambini di ogni età e abilità grazie alla magia e all'intuizione del gioco lasciando libere la loro creatività ed immaginazione.

YOKO

YOKO CASTILLO

Questa serie di composizioni, grazie ad un design semplice ma accattivante, è idonea ad un'ampia fascia d'età e offre molteplici possibilità ludiche. Sono state introdotte torrette per offrire una varietà di attività diverse e stimolanti, dove il livello di sfida è alla portata di tutti. Lo scopo è quello di trasmettere ai bambini la consapevolezza che ciascuno di loro può mostrare in modo diverso ciò che ha appreso promuovendo la formazione del carattere attraverso il gioco.





YOAB4001HJ

Yoko 4001 Marina

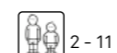

2 - 11



737x574x423h



1074x843



m² 72



150h

YOAB4001HI

Yoko 4001 Castillo

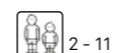

2 - 11



737x574x423h



1074x843



m² 72









150h





YOAB3001HJ

Yoko 3001 Marina

-  3 - 11
-  641x630x417h
-  988x977 m² 52
-  988x977 m² 52
-  m² 56,5
-  150h

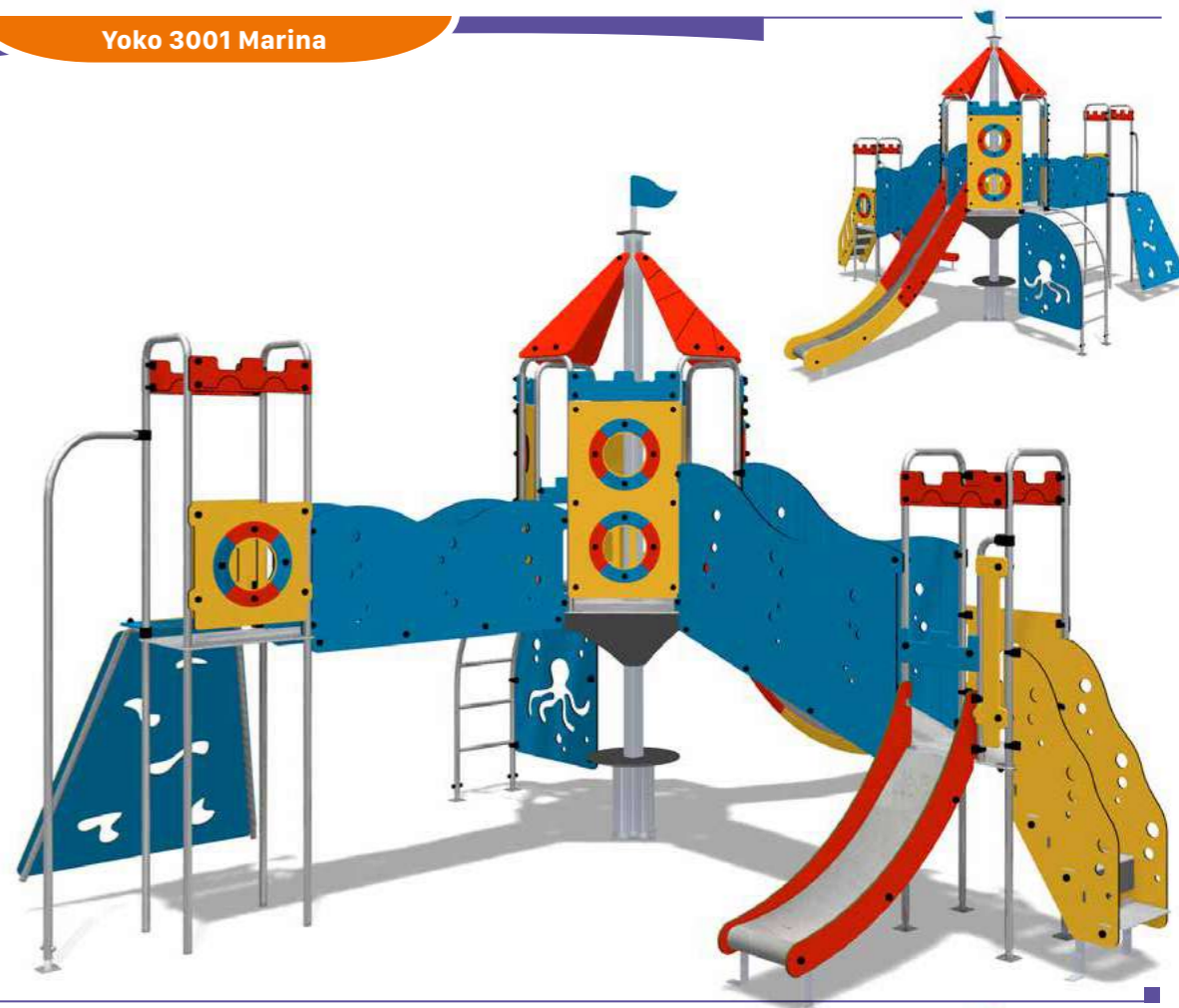







YOAB3002HJ

Yoko 3002 Oplà Marina

YOAB3003









Yoko Oplà è disponibile anche nella versione ad angolo

- 
-  2 - 11
-  1332x332x361h
-  1652x641 m² 66,58
-  425x345 + 300x200 m² 20,54
-  m² 24,5
-  150h



YOAB3001HI



Yoko 3001 Castillo

-  3 - 11
-  641x630x417h
-  988x977 m² 52
-  988x977 m² 52
-  m² 56,5
-  150h



YOAB2002HJ



Yoko 2002 Marina

-  2 - 8
-  631x262x417h
-  978x555 m² 38
-  978x555 m² 35,48
-  m² 42
-  150h



YOAB2002HI

Yoko 2002 Castillo

-  2 - 8
-  631x262x417h
-  978x555 m² 38
-  978x555 m² 35,48
-  m² 42
-  150h



YOAA1001HJ **Yoko 1001 Marina**



- 1 - 6
- 452x390x417h
- 798x688 m² 32,80
- 824x674 m² 32,50
- m² 38
- 150h

YOAB2003HI **Yoko 2003 Castillo**



- 2 - 8
- 455x158x243h
- 814x458 m² 28,8
- 807x394 m² 25,7
- m² 32,5
- 90h

YOAA1001HI **Yoko 1001 Castillo**



- 1 - 6
- 452x390x417h
- 798x688 m² 32,80
- 824x674 m² 32,50
- m² 38
- 150h

ATTREZZI GINNICI E DI EQUILIBRIO

YOA11001ZID **Yoko Castillo Jim 1**



- 3 - 8
- 170x107x245h
- 534x534 m² 21,7
- 468x468 m² 16,5
- m² 20
- 99h

Due, Quattro o Cinque posti

L'elemento più popolare nel parco giochi

Questa altalena è unica perché il suo palo di supporto è al centro, è disponibile con montanti in tubolare di acciaio zincato a caldo e verniciato. I sedili possono essere combinati secondo le proprie esigenze. I nostri giunti cardanici, in acciaio inossidabile forgiato a caldo con sistema anti avvolgimento della catena, applicati alle altalene, assicurano alle catene dei sedili una durabilità eccezionale. La particolarità consiste nel fatto che il giunto in acciaio derivato dal pieno evita lo sfregamento e quindi l'usura degli anelli.

Contattare l'ufficio vendite per ulteriori informazioni sui dettagli di installazione o di sicurezza.



A431014



Sedile tavoletta "C"

A431015



Sedile a gabbia "D"

SRF124



Sedile Inclusivo OpIà "M"

A431031



Sedile Inclusivo "T"



Sedile tavoletta "O"

YOEAE1001V

Duolena

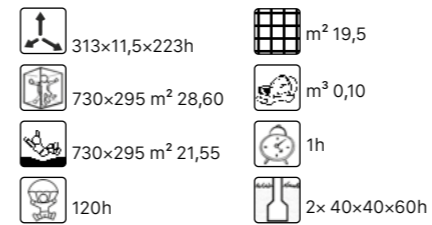

YOEAE1001Z



Duolena è disponibile anche nella versione con montanti zincati

YOEAE1001VCZG



YOEAE1001VGZG



YOEAE1001VNZG



YOEAE1001VVZG

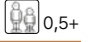

YOEAE1002V

Quadrilena

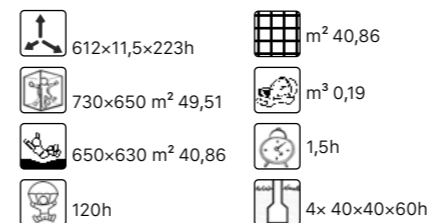

YOEAE1002Z



Quadrilena è disponibile anche nella versione con montanti zincati

YOEAE1002VGZG



YOEAE1002VDZG



YOEAE1002VNZG

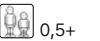

YOEAE1003VO

Pentalena

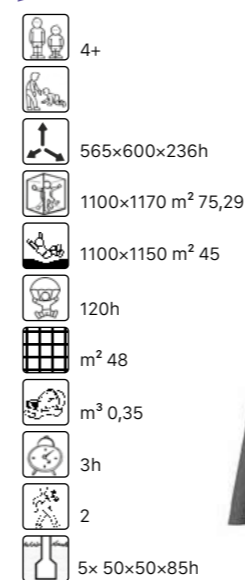

YOEAE1003Z



Pentalena è disponibile anche nella versione con montanti zincati







Togo

un tocco di colore nel mondo dei bambini



per bambini fino **8** anni

Togo è la linea di TLF progettata per offrire la possibilità di introdurre articoli dai colori vivaci nel contesto di aree gioco all'aperto. Questi design possono essere combinati per completare spazi ludici vari e stimolanti, che riflettano gli interessi e le necessità dei piccoli utenti.

L'ottimo rapporto fra colori e ambienti all'aperto

Secondo gli esperti, due sono i benefici principali connessi alla presenza di colori vivaci negli spazi aperti ideati per il gioco dei bambini: il primo riguarda il fatto che i bambini molto piccoli riconoscono gli oggetti più per colori associati che per la loro forma. Questo significa che, selezionando con cura oggetti dai colori ben distinti, i bambini possono sviluppare una rapida mappa per potersi orientare. Questo può avvenire solamente se i colori vengono usati in modo razionale, piuttosto che riempiendo a caso lo spazio di colori e forme vivaci.

Il secondo beneficio legato all'importanza di una scelta attenta dei colori è rappresentato dal fatto che i bambini con disabilità visiva sono in grado di orientarsi meglio e in modo più sicuro all'interno di un'area gioco con forti colori contrastanti, che li aiutano a distinguere le attrezzature ludiche dallo sfondo e a identificare gli spazi o le variazioni di livello all'interno di una singola struttura ludica.

Inoltre è anche vero che i colori brillanti si associano al divertimento, alle feste e alla felicità. Questo tipo di

risposta al colore è stata sempre riscontrata fin dagli albori dell'umanità, molto prima dell'invenzione delle vernici moderne e della fotografia a colori.

Colori che stimolano il gioco

TLF è estremamente favorevole alla creazione di parchi gioco dove i bambini possano avere accesso ad un mondo naturale di qualità, anche se cosciente del fondamentale elemento culturale e urbano connesso alle reazioni dei bambini rispetto all'ambiente. Disponiamo della tecnologia adeguata per inserire colori nell'ambiente ludico, operazione che può portare molti benefici, se attentamente ponderata.

La nuova linea **Togo** di TLF è progettata per offrire la possibilità di introdurre articoli dai colori vivaci nel contesto di aree gioco all'aperto. Questi design possono essere combinati con gli articoli delle nostre serie come Gardenia o Modulo Più, per completare spazi ludici vari e stimolanti, che riflettano gli interessi e le necessità dei piccoli utenti.



I colori che segnalano il gioco e accrescono nei bambini la curiosità e la comprensione degli spazi e delle forme



Possibilità di apprendimento del gioco di cooperazione e del gioco integrato



Vasta gamma di articoli per i giochi di socializzazione e di ruolo da inserire nell'area gioco

I montanti delle strutture sono disponibili anche in alluminio con la parte terminale in acciaio zincato a caldo, per evitare la corrosione delle corrente vaganti



I pannelli e le sponde degli scivoli sono disponibili in HPL e HDPE. Materiali di grande resistenza agli agenti atmosferici

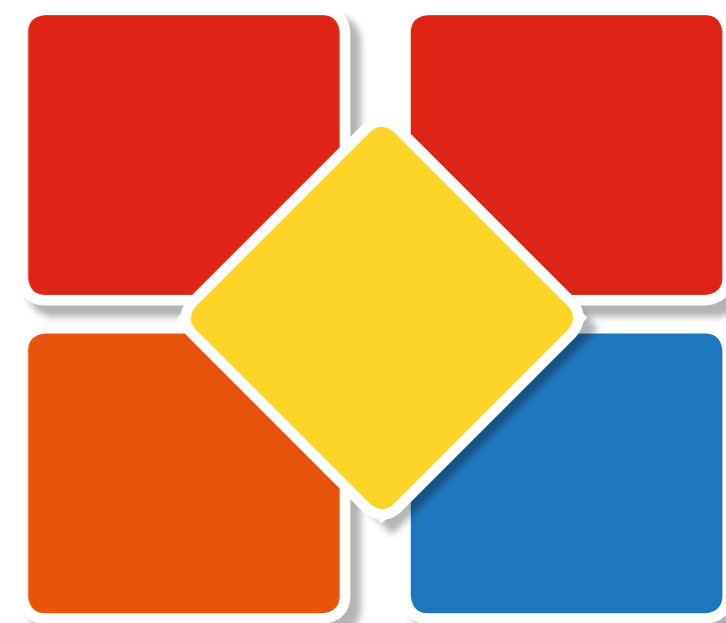

Le pedane dei piani e delle scale sono realizzate in HPL con superficie ruvida per conferire un adeguato grip in qualsiasi condizione





Togo

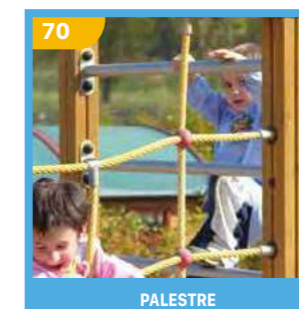
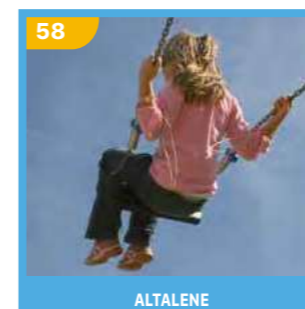



Le pedane dei piani e delle scale sono realizzate in HPL con superficie a rilievo per conferirle un adeguato grip in qualsiasi condizione.













TOAB2002

Togo B 2002



Togo è disponibile anche nella versione con montanti in legno



-  2 - 8
-  339x378x346h
-  625x728 m² 37,1
-  625x675 m² 33,3
-  145,5h
-  m² 36,38
-  8x 50x50x85h
-  6x 25x25x85h
-  2
-  m³ 0,82
-  7 h











TOAB2051

Togo B 2051



Togo è disponibile anche nella versione con montanti in legno



-  2 - 8
-  335x386x341h
-  628x736 m² 33,3
-  628x658 m² 29,25
-  145,5h
-  m² 33,5
-  9x 50x50x85h
-  2x 25x25x85h
-  2
-  m³ 0,83
-  5 h

TOAB2004 Togo B 2004

- 2 - 8
- 552x311x318h
- 894x648 m² 40,85
- 894x648 m² 35,90
- 145,5h
- m² 41,5
- 10x 50x50x85h
 6x 25x25x85h m³ 0,99
- 2 7 h



Togo è disponibile anche nella versione con montanti in legno

TOAB2006 Togo B 2006

- 1 - 5
- 533x220x306h
- 883x503 m² 36,48
- 849x500 m² 33,02
- 90h
- m² 37,38
- 8x 50x50x85h
 4x 25x25x85h m³ 0,78
- 2 7 h



Togo è disponibile anche nella versione con montanti in legno

TOAB2005 Togo B2005 Oplà



Togo è disponibile anche nella versione con montanti in legno

- 503x565 m² 20,10
- 2 - 8 90 h
- 676x458x284 h m² 22,25
- 976x759 m² 53,95 2

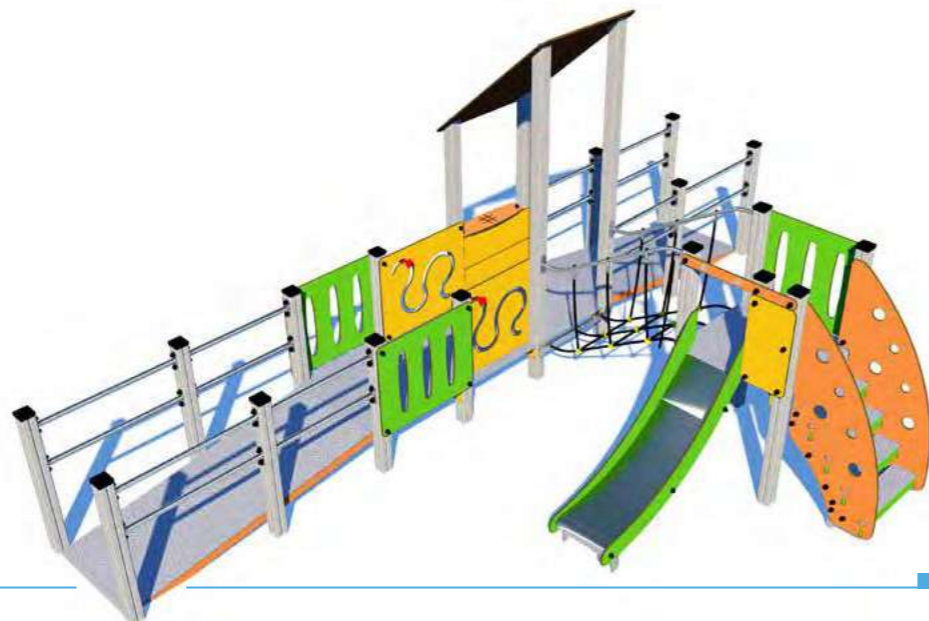

TOAB2010 Togo B 2010

- 2 - 8
- 578x339x346h
- 928x628 m² 46,74
- 978x625 m² 40,50
- 145,5h
- m² 36,38
- 8x 50x50x85h
 6x 25x25x85h m³ 0,82
- 2 7 h

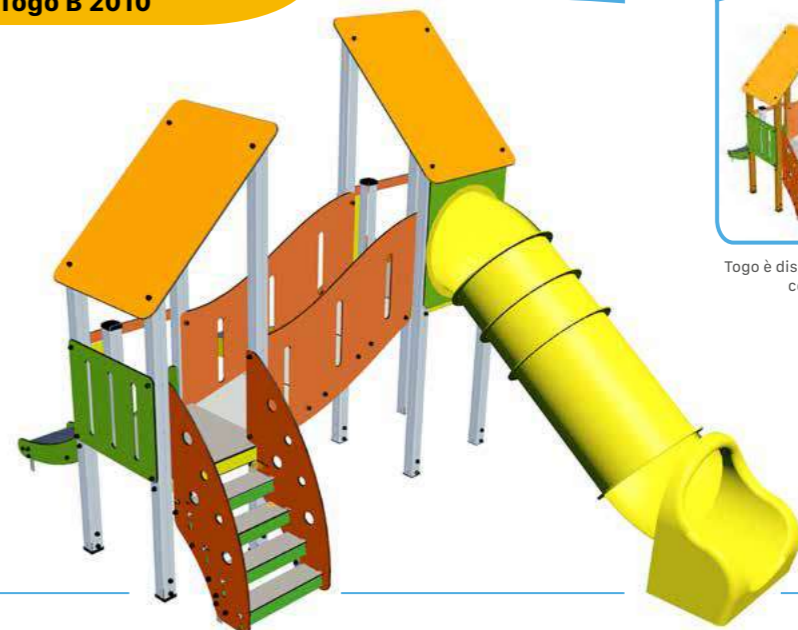

Togo è disponibile anche nella versione con montanti in legno

TOAB3050 Togo B 3050

- 2 - 8
- 463x412x346h
- 837x695 m² 42,3
- 837x625 m² 40,6
- 145,5h
- m² 46,3
- 13x 50x50x85h
 4x 25x25x85h m³ 1,22
- 2 10 h



Togo è disponibile anche nella versione con montanti in legno



TOAC1102

Piroscifo

- 0,5 - 6
- 565x374x339h
- 833x719 m² 41,74
- 470x681 m² 20,04
- 88,5h
- m² 29
- 14x 50x50x50h
3x 25x25x50h
3x 25x25x50h
- m³ 1,3
- 6h
- 3



Togo è disponibile anche nella versione con montanti in legno

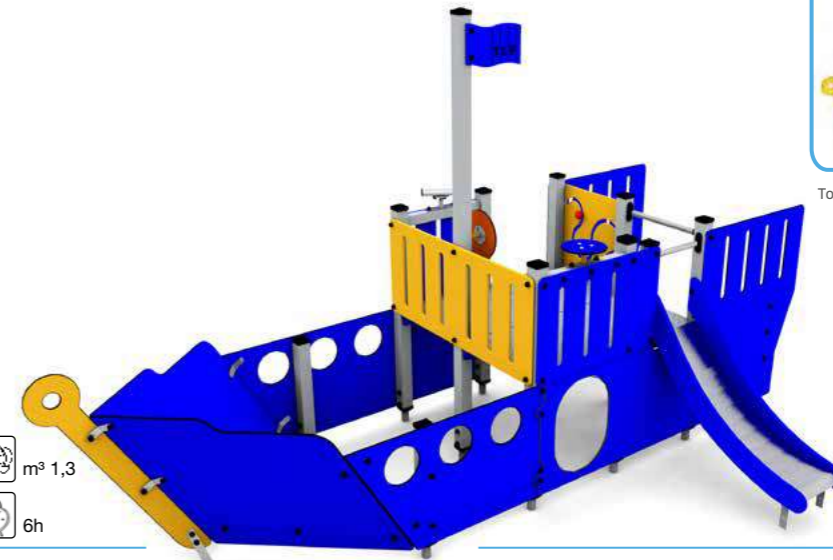

designer: Fabio Casadei

TOAC1103

Pilotina



Togo è disponibile anche nella versione con montanti in legno

- 0,5 - 6
- 492x305x341h
- 788x650 m² 37,35
- 408x650 m² 21,32
- 88,5h
- m² 23,75
- 11x 50x50x50h
3x 25x25x50h
- m³ 1,01
- 6h
- 2

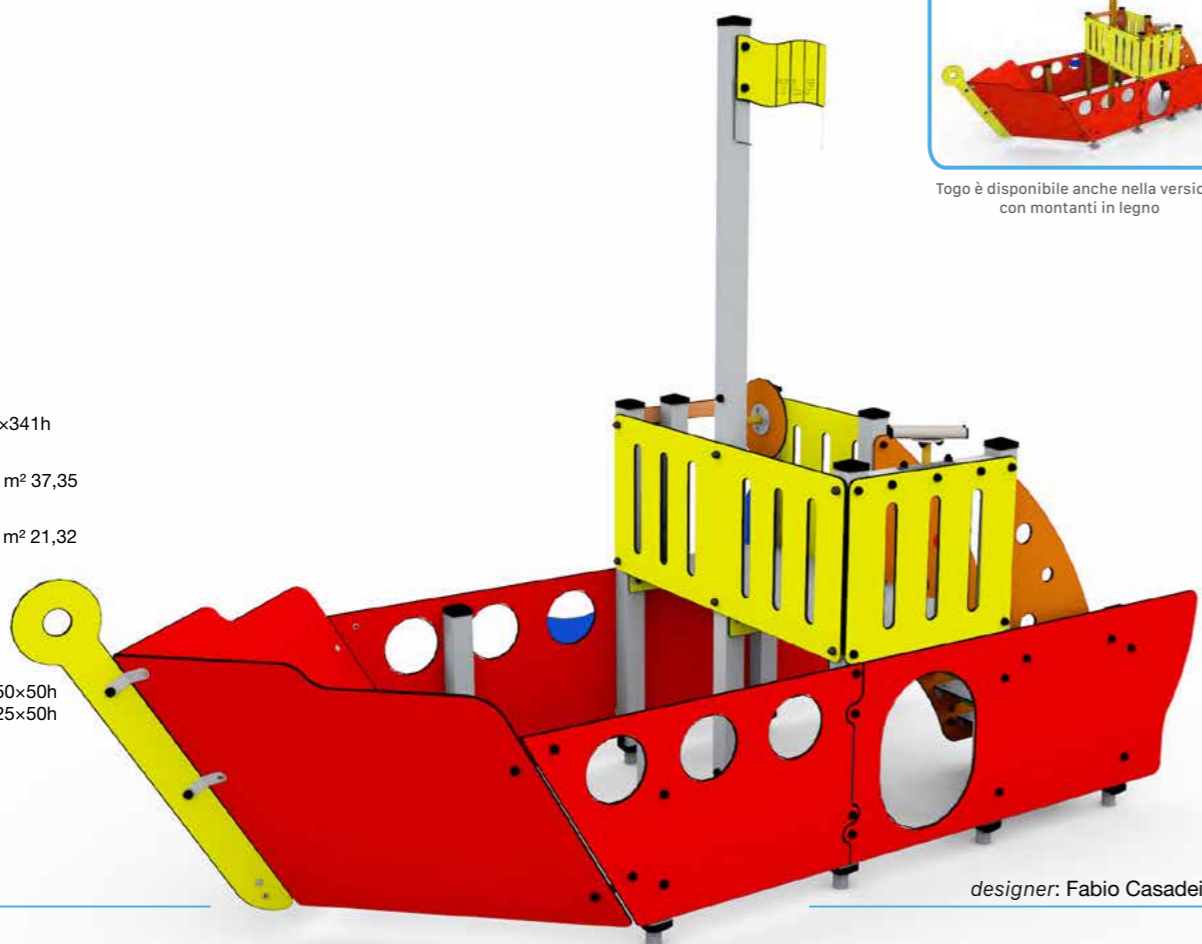

designer: Fabio Casadei

TOAC1106

Trabaccolo

- 0,5 - 6
- 491x171x257h
- 791x471 m² 31
- 791x471 m² 31
- <95h
- 3x 25x25x50h
3x 25x25x50h
- m³ 1,3
- 6h
- 3



designer: Fabio Casadei

TOAC1107

Trabaccolo Prua

- 0,5 - 6
- 197x173x256h
- 496x472 m² 18,5
- 496x472 m² 18,5
- <95h
- 3x 25x25x50h
- m³ 0,7
- 3h
- 2



designer: Fabio Casadei

TOAA1020 **Togo A 1020**



- 3 - 8
- 335x473x306h
- 820x632 m² 40,36
- 820x632 m² 39,45
- <100h
- 12x 50x50x85h



Togo è disponibile anche nella versione con montanti in legno

TOAA1021 **Togo A 1021**



- 3 - 8
- 579x336x306h
- 927x632 m² 47,15
- 927x632 m² 46,23
- <100h
- 14x 50x50x85h



Togo è disponibile anche nella versione con montanti in legno

TOAD1054 **Togo D 1054**

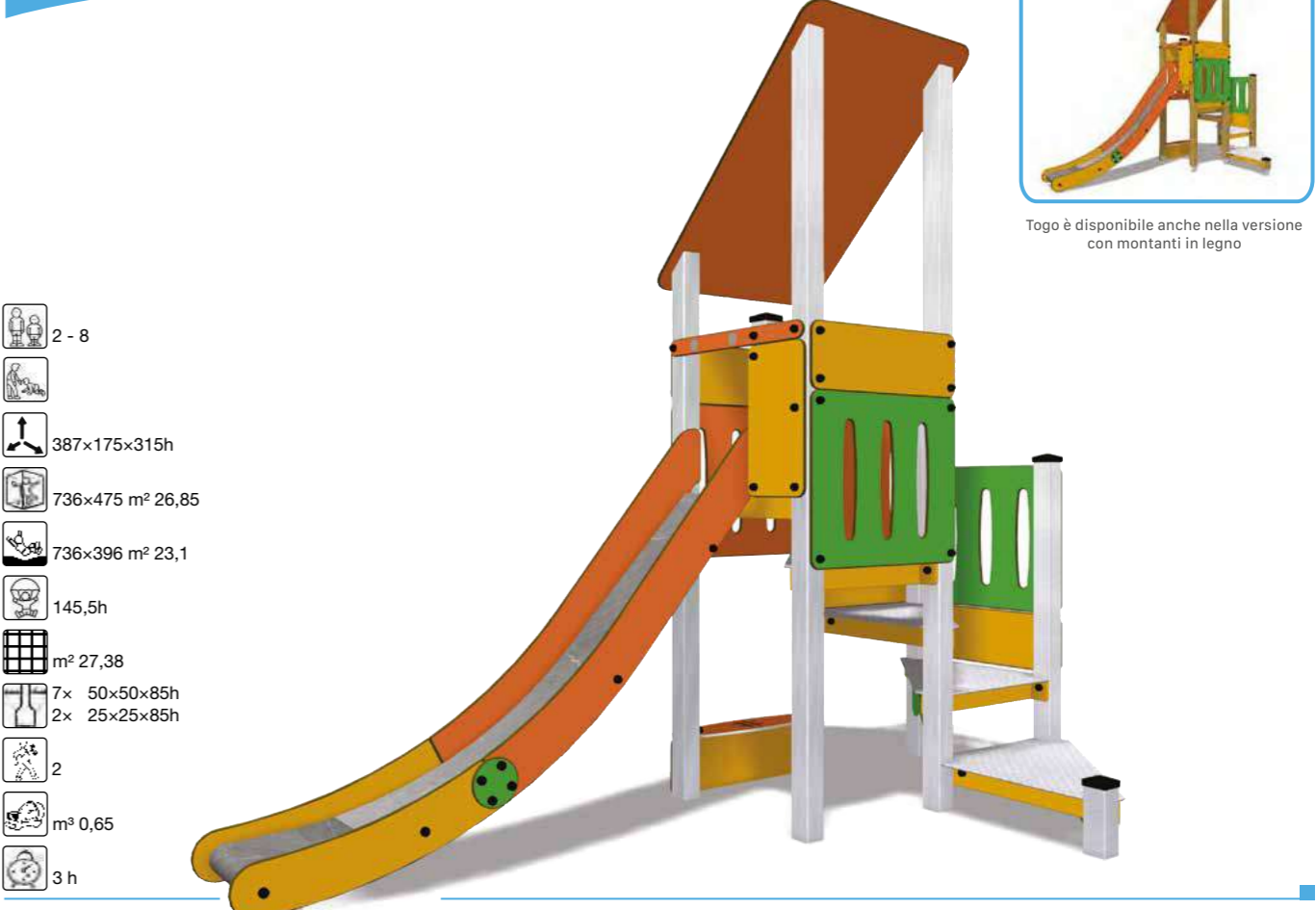

- 2 - 8
- 387x175x315h
- 736x475 m² 26,85
- 736x396 m² 23,1
- 145,5h
- m² 27,38
- 7x 50x50x85h
2x 25x25x85h
- 2
- m³ 0,65
- 3 h



Togo è disponibile anche nella versione con montanti in legno

TOAD1056 **Togo D 1056**



- 3 - 8
- 496x232x346h
- 849x530 m² 33,35
- 750x497 m² 25,95
- 145,5h
- m² 28,5
- 4x 50x50x85h
4x 25x25x85h
4x 25x25x85h
- 2
- m³ 0,45
- 3 h



Togo è disponibile anche nella versione con montanti in legno

TOAD1057

Togo D 1057



Togo è disponibile anche nella versione con montanti in legno

- 1 - 5
- 295x176x261h
- 640x467 m² 23,75
- 587x467 m² 20,60
- 88,5h
- m² 24,12
- 6x 50x50x85h
4x 25x25x85h
- 2
- m³ 0,6
- 3 h



TOAD1058

Togo D 1058



Togo è disponibile anche nella versione con montanti in legno

- 3 - 8
- 382x177x261h
- 727x467 m² 27,4
- 727x467 m² 25,9
- 88,5h
- m² 30
- 6x 50x50x85h
4x 25x25x85h
- 2
- m³ 0,45
- 4 h















TOAD1059

Togo D 1059



Togo è disponibile anche nella versione con montanti in legno

-  2 - 8
-  
-  409x176x318h
-  758x467 m² 27,9
-  725x467 m² 24,7
-  145,5h
-  m² 29,12
-  6x 50x50x85h
 4x 25x25x85h
-  2
-  m³ 0,6
-  3 h















TOAD1060

Togo D 1060







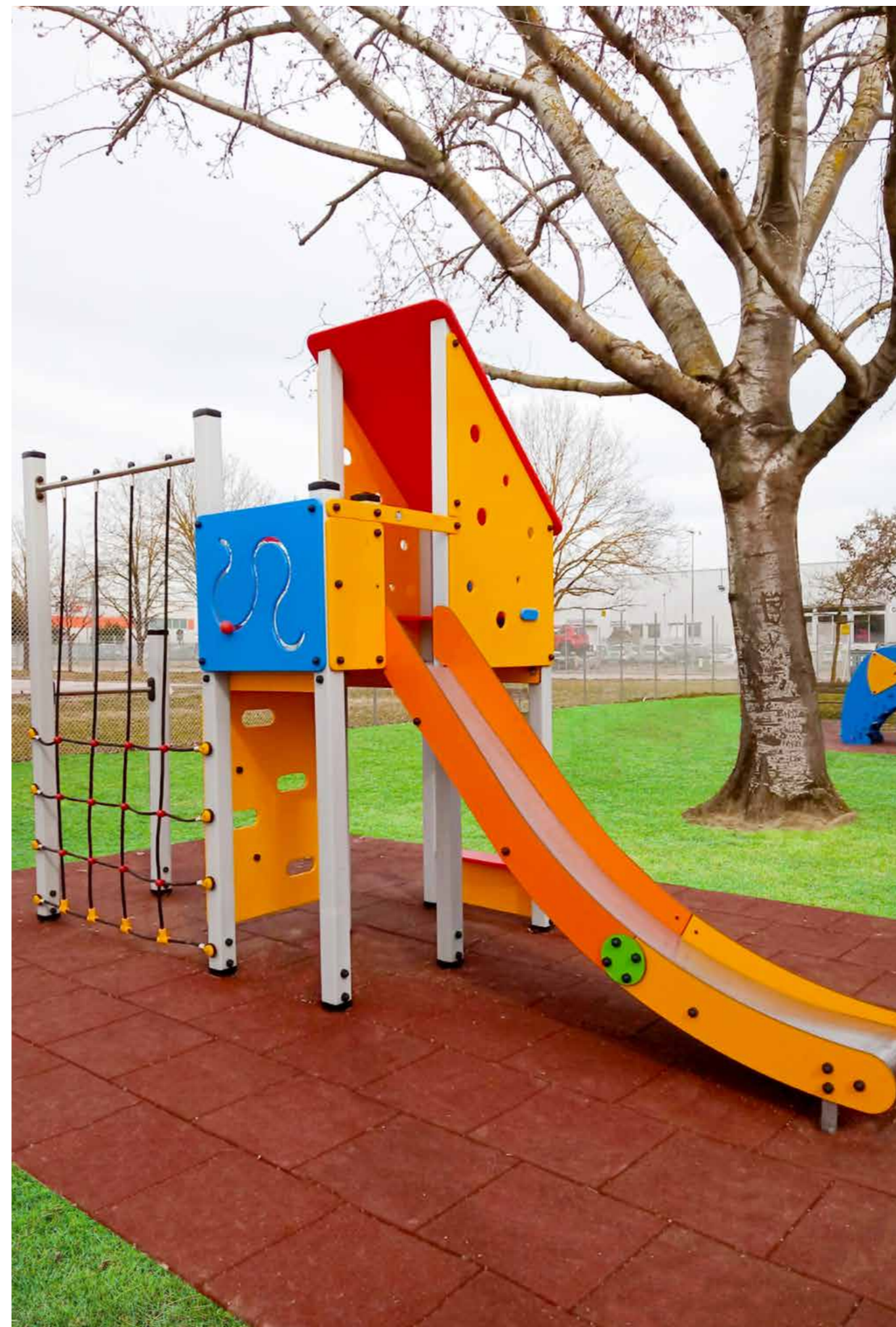





Togo è disponibile anche nella versione con montanti in legno

-  3 - 8
-  
-  465x176x318h
-  815x467 m² 30,40
-  815x467 m² 28,4
-  145,5h
-  m² 32,12
-  8x 50x50x85h
 2x 25x25x85h
-  2
-  m³ 0,74
-  4 h



TOAG1002

Togo G 1002









-  1 - 5
-  $226 \times 161 \times 169\text{h}$
-  $570 \times 459\text{ m}^2$ 21,25
-  $570 \times 406\text{ m}^2$ 17,8
-  88,5h
-  m^2 20
-  4x $50 \times 50 \times 85\text{h}$
-  4x $25 \times 25 \times 85\text{h}$
-  m^3 0,43
-  2 h



Togo è disponibile anche nella versione con montanti in legno

TOAC1101

Elefantino



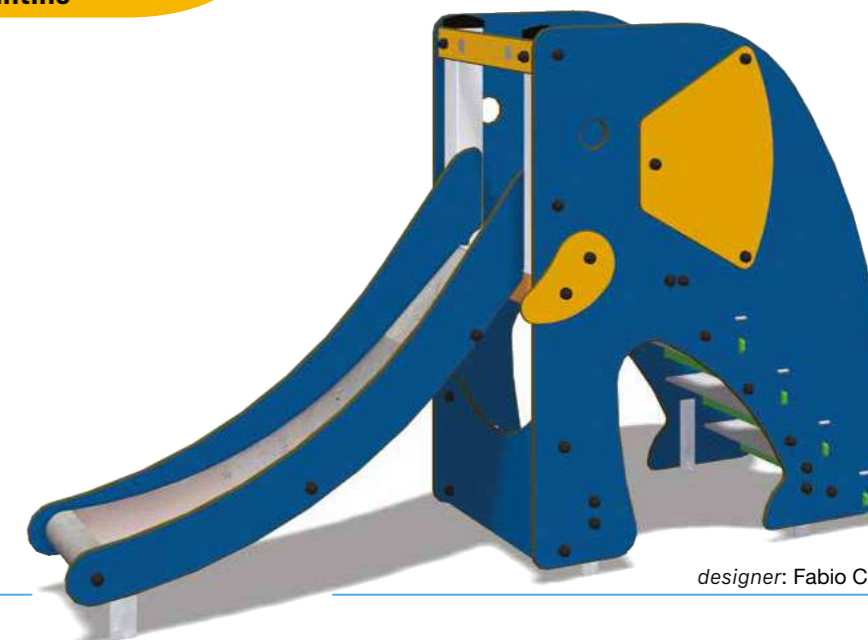







-  1 - 5
-  $260 \times 71 \times 161\text{h}$
-  $605 \times 371\text{ m}^2$ 19,8
-  $568 \times 372\text{ m}^2$ 16,8
-  88,5h
-  m^2 20
-  6x $25 \times 25 \times 85\text{h}$
-  m^3 0,56
-  2 h



designer: Fabio Casadei

TOAG1054

Togo G 1054









-  2 - 8
-  $314 \times 196 \times 346\text{h}$
-  $657 \times 490\text{ m}^2$ 25,42
-  $657 \times 456\text{ m}^2$ 22,16
-  145,5h
-  m^2 26,12
-  4x $50 \times 50 \times 85\text{h}$
-  4x $25 \times 25 \times 85\text{h}$
-  m^3 0,43
-  3 h



Togo è disponibile anche nella versione con montanti in legno

TOAC1104

Dino











-  1 - 5
-  $209 \times 69 \times 142\text{h}$
-  $559 \times 369\text{ m}^2$ 18,72
-  $196 \times 245\text{ m}^2$ 4,37
-  $\leq 60\text{h}$
-  m^2 5
-  6x $25 \times 25 \times 85\text{h}$
-  m^3 0,56
-  2 h



designer: Fabio Casadei

TOAG1056

Togo G 1056



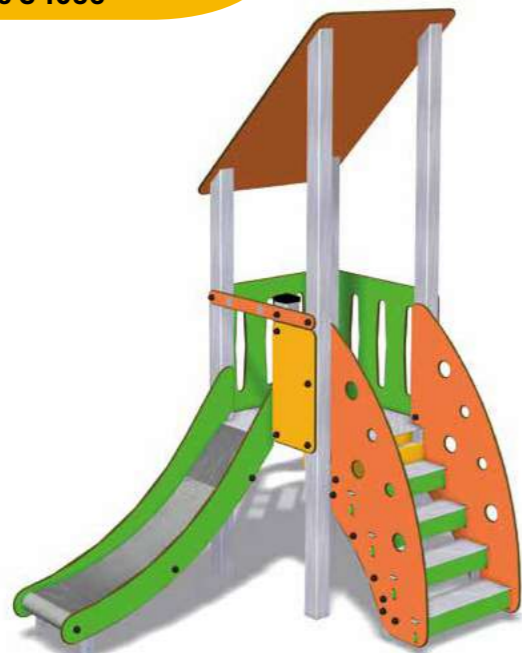







-  1 - 5
-  $230 \times 167 \times 305\text{h}$
-  $570 \times 460\text{ m}^2$ 21,35
-  $570 \times 408\text{ m}^2$ 17,90
-  88,5h
-  m^2 20,25
-  4x $50 \times 50 \times 85\text{h}$
-  4x $25 \times 25 \times 85\text{h}$
-  m^3 0,43
-  2,5h



Togo è disponibile anche nella versione con montanti in legno

TOAG0001

Scivolo Togo h 90











-  2 - 7
-  $210 \times 72 \times 184\text{h}$
-  $367 \times 555\text{ m}^2$ 17,6
-  $367 \times 542\text{ m}^2$ 15,5
-  88,5h
-  m^2 18
-  2x $50 \times 50 \times 60\text{h}$
-  2x $25 \times 25 \times 60\text{h}$
-  m^3 0,25
-  1,5 h



Disponibile anche nella versione con montanti in legno

TOAG0002

Scivolo Togo h 150

-  3 - 7
-  $313 \times 72 \times 241\text{h}$
-  $367 \times 663\text{ m}^2$ 21,6
-  $367 \times 648\text{ m}^2$ 19
-  145,5h
-  m^2 22
-  2x $50 \times 50 \times 60\text{h}$
-  2x $25 \times 25 \times 60\text{h}$
-  m^3 0,25
-  1,5 h

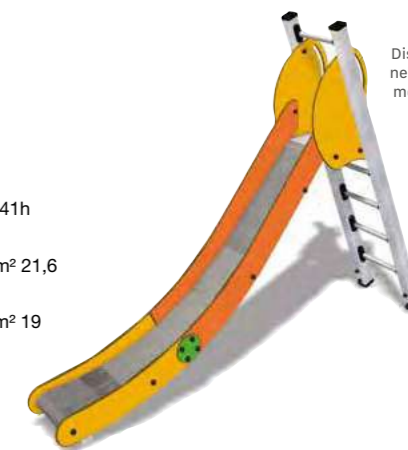

Disponibile anche nella versione con montanti in legno

Altalene

Tutti gli studi sull'uso delle altalene mostrano che sono l'elemento più popolare nel parco giochi.

Prodotte per oltre 35 anni, le nostre altalene sono un elemento di gioco popolare che è costruito per durare. Sono molto robuste, disponibili con montanti in alluminio, legno e tubolare di acciaio zincato a caldo e verniciato. I quattro sedili disponibili possono essere combinati secondo le proprie esigenze. I nostri giunti cardanici, in acciaio inox forgiato a caldo con sistema anti avvolgimento della catena, applicati alle altalene, assicurano alle catene dei sedili una durabilità eccezionale. La particolarità consiste nel fatto che il giunto in acciaio derivato dal pieno evita lo sfregamento e quindi l'usura degli anelli. **Contattare l'ufficio vendite per ulteriori informazioni sui dettagli di installazione o di sicurezza.**



A431014



Sedile tavoletta "C"

A431015



Sedile a gabbia "D"

SRF124



Sedile Inclusivo Opà "M"

A431031



Sedile Inclusivo "T"

TOAE100

Camilla 1 posto

	147x268x223h
	462x730 m ² 22,99
	200x650 m ² 21,39
	120h
	m ² 13
	m ³ 0,19
	1h
	2
	4x 40x40x60h



TOAE1001CZDS



TOAE1001DZDS



TOAE1001MZDS



TOAE1001TZDS



TOAE1001CZWS



TOAE1001DZWS



TOAE1001MZWS



TOAE1001TZWS



TOAE1003CZGS



TOAE1003DZGS



TOAE1003MZGS











TOAE1003TZGS



Le versioni indicate sono con plinti da 600 mm, disponibili a richiesta anche da 150 mm e 900 mm.

TOAE200

Camilla 2 posti

-  147x381x223h
-  579x730 m² 30,70
-  300x650 m² 19,50
-  120h
-  m² 19,5
-  m³ 0,19
-  1,5h
-  2
-  4x 40x40x60h

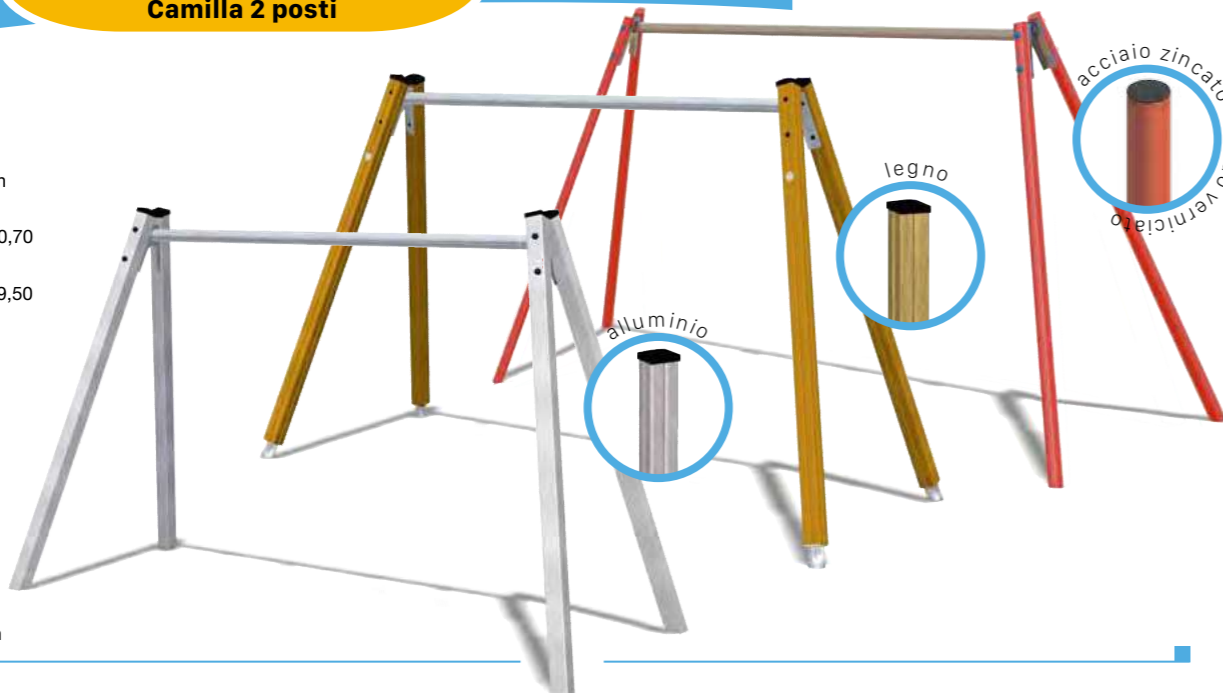

TOAE2001CZDS

 2,5+

TOAE2001GZDS

 0,5 - 2,5

TOAE2001PZDS

 2,5+

TOAE2001SZDS

 0,5+

TOAE2001CZWS

 2,5+

TOAE2001GZWS

 0,5 - 2,5

TOAE2001PZWS

 2,5+

TOAE2001SZWS

 0,5+

TOAE2003CZGS

 2,5+

TOAE2003GZGS

 0,5 - 2,5

TOAE2003PZGS

 2,5+

TOAE2003SZGS

 0,5+

Le versioni indicate sono con plinti da 600 mm, disponibili a richiesta anche da 150 mm e 900 mm.

TOAE1002

Cipi



-  1,5 - 5
-  154x303x223h
-  500x715 m² 25,77
-  250x715 m² 17,87
-  117h
-  m³ 0,35
-  m² 16,5
-  1h
-  2
-  4x 50x50x85h



Disponibile anche nella versione con montanti in legno



Disponibile anche nella versione con montanti in acciaio zincato a caldo e verniciati

TOAH1080

Bunny

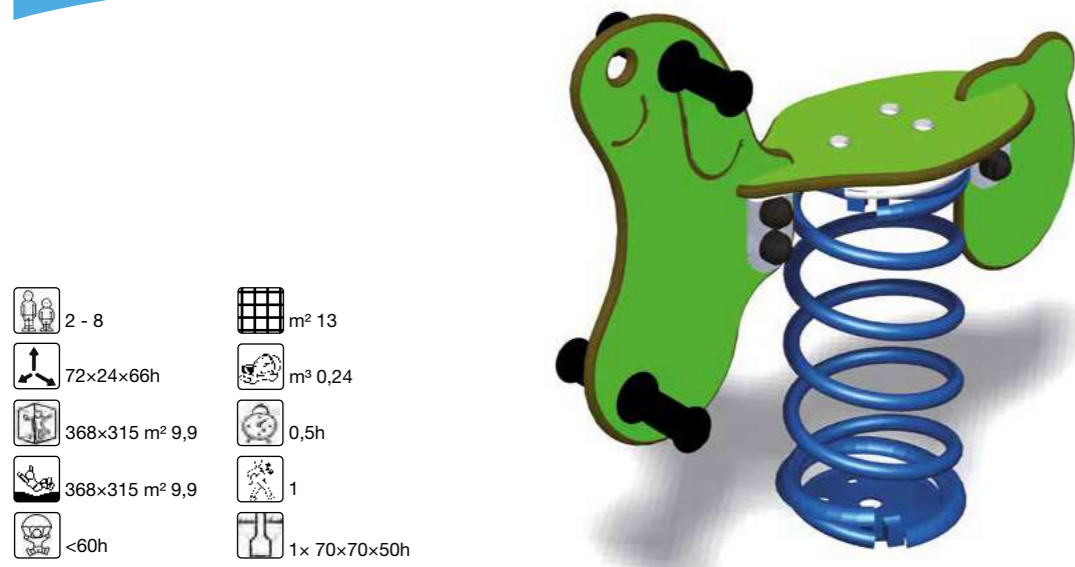

2 - 8	m ² 13
72x24x66h	m ³ 0,24
368x315 m ² 9,9	0,5h
368x315 m ² 9,9	1
<60h	1x 70x70x50h

TOAH1081

Felix

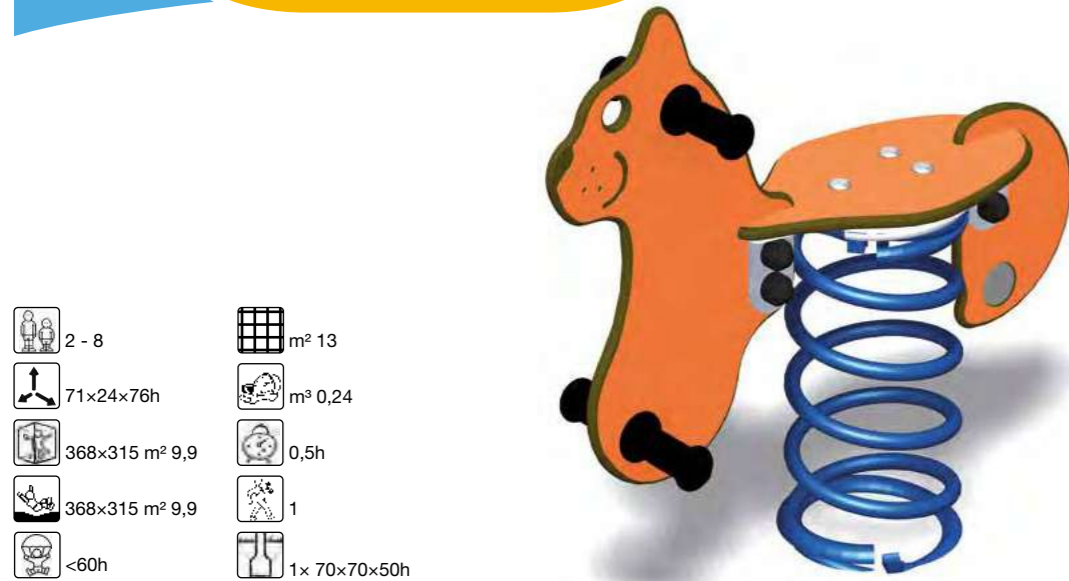

2 - 8	m ² 13
71x24x76h	m ³ 0,24
368x315 m ² 9,9	0,5h
368x315 m ² 9,9	1
<60h	1x 70x70x50h

TOAH1082

Dido

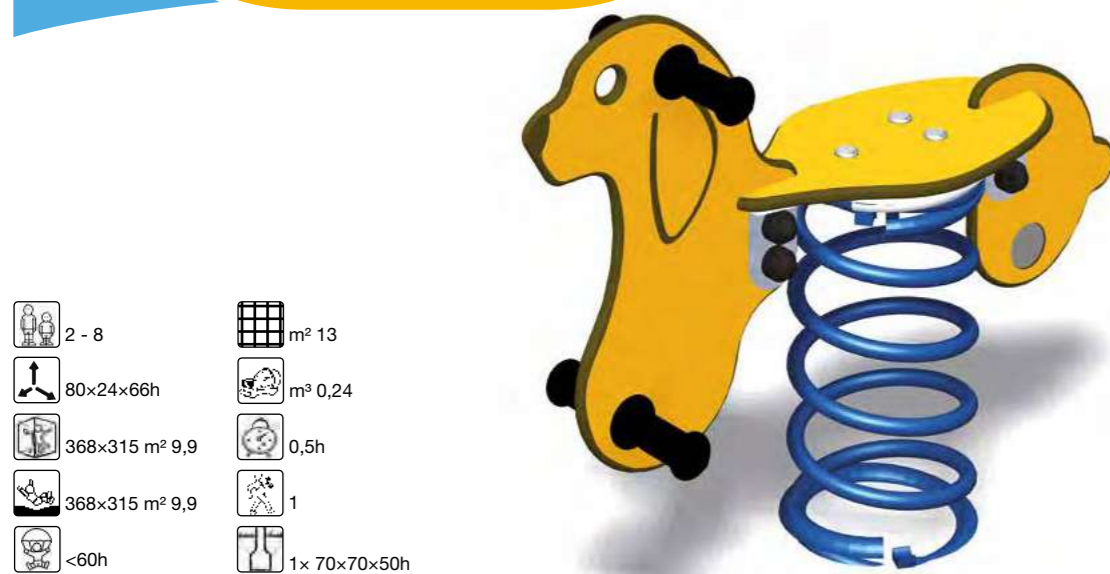

2 - 8	m ² 13
80x24x66h	m ³ 0,24
368x315 m ² 9,9	0,5h
368x315 m ² 9,9	1
<60h	1x 70x70x50h

TOAH1083

Canarino

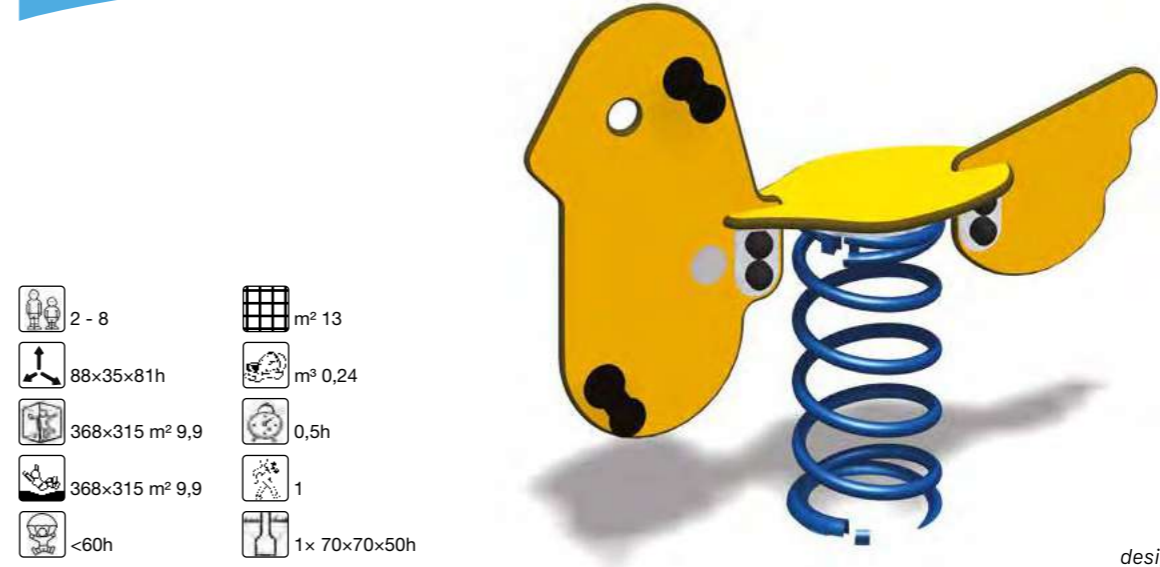

2 - 8	m ² 13
88x35x81h	m ³ 0,24
368x315 m ² 9,9	0,5h
368x315 m ² 9,9	1
<60h	1x 70x70x50h

designer: Fabio Casadei

TOAH1084

Pony

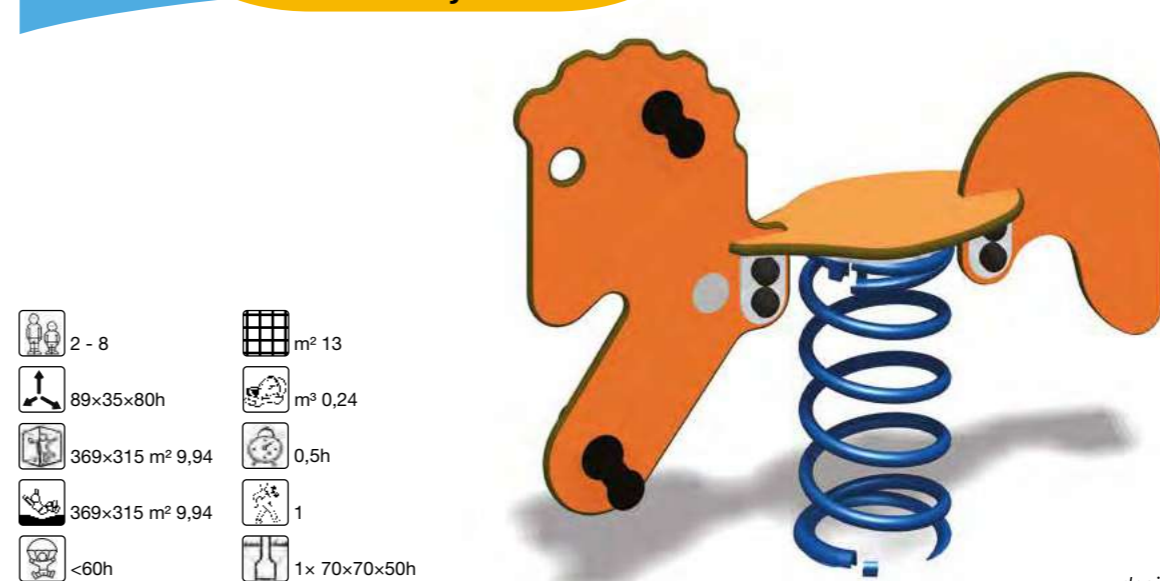

2 - 8	m ² 13
89x35x80h	m ³ 0,24
369x315 m ² 9,94	0,5h
369x315 m ² 9,94	1
<60h	1x 70x70x50h

designer: Fabio Casadei

TOAH1085

Duck

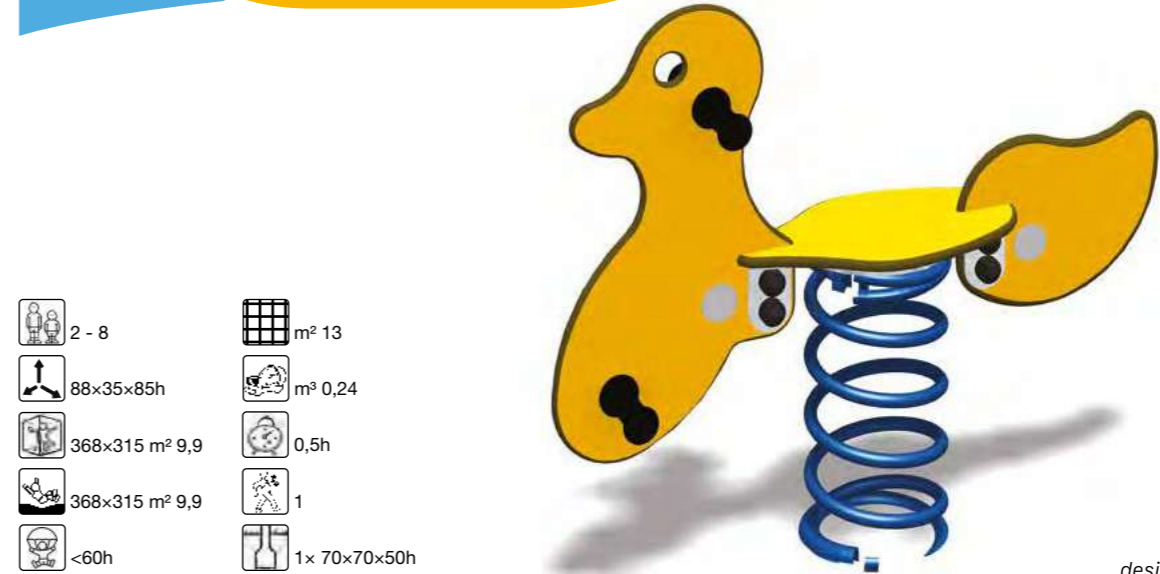

2 - 8	m ² 13
88x35x85h	m ³ 0,24
368x315 m ² 9,9	0,5h
368x315 m ² 9,9	1
<60h	1x 70x70x50h

designer: Fabio Casadei

TOAH1086

Mille Miglia Inclusivo



m² 14

m³ 0,24

0,5h

1

1x 70x70x50h

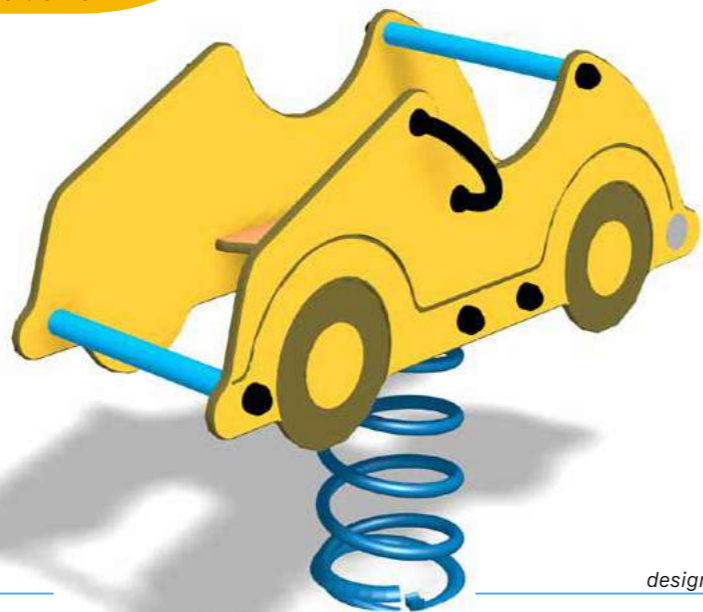

designer: Fabio Casadei

TOAH1087

Snapper



m² 14

m³ 0,24

0,5h

1

1x 70x70x50h



designer: Fabio Casadei

TOAH1088

Froggy



m² 14

m³ 0,24

0,5h

1

1x 70x70x50h

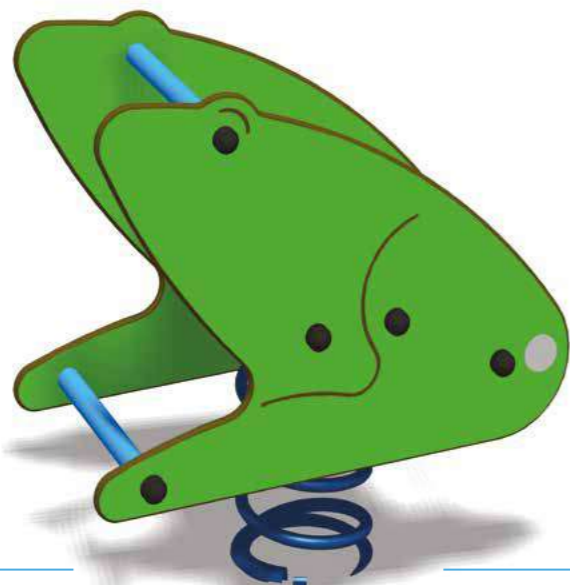

designer: Fabio Casadei

TOAH1089

Snapper Duo



m² 13,5

m³ 0,5

1h

2

2x 70x70x50h

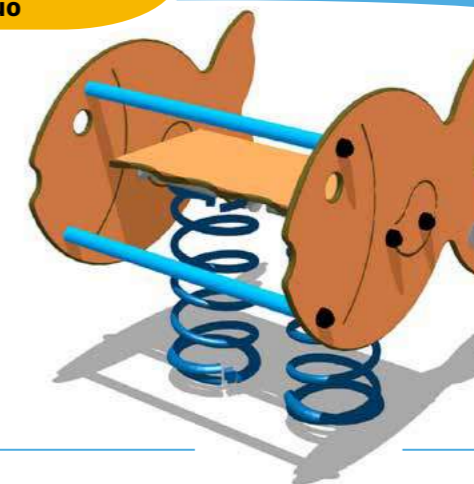

TOAH2080

Aries



m² 14

m³ 0,24

0,5h

1

1x 70x70x50h



TOAH4080

Tiramolla



m² 15

m³ 0,24

1h

1

1x 70x70x50h



designer: Fabio Casadei

TOAH4081

Meduse



m² 21

m³ 0,49

1h

2

2x 70x70x50h



designer: Fabio Casadei



TOAH1011 Bilico Gondola

- 2 - 12
- 328x123x115h
- 627x427 m² 23,16
- 327x527 m² 15
- <94h

designer: Fabio Casadei

TOAH1001 Luma X

Disponibile anche nella versione con montanti in legno

- 2 - 12
- 410x61x86h
- 710x345 m² 20,80
- 710x345 m² 20,80
- 94h
- m² 25,5
- m³ 0,09
- 0,5h
- 1
- 2x 40x40x65h
2x 40x40x60h

TOAH1002 Luma Luma X

Disponibile anche nella versione con montanti in legno

- 2 - 12
- 410x61x86h
- 710x345 m² 20,80
- 710x345 m² 20,80
- 94h
- m² 25,5
- m³ 0,09
- 0,5h
- 1
- 2x 40x40x65h
2x 40x40x60h



TOZH1002 Giostrina accessibile

- 3 - 14
- Ø180x59 h
- Ø577 m² 24
- Ø577 m² 24
- <60 h

TOZH1003 Giostrina accessibile con volano

- 3 - 14
- Ø180x59 h
- Ø577 m² 24
- Ø577 m² 24
- <60 h

TOZH1001A

Girella

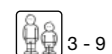

3 - 9



Ø145x67h



Ø545 m² 23



Ø545 m² 23



67h



m² 0,40



m² 30,25



2h



2 - 3



1x 115x115x30h



designer: Fabio Casadei

TOZH1001C

Tazzy rotante



5+



55x65x65h



455x465













65h



TOAI1001

Togo Jim 1











-  6 - 9
-  247x168x212h
-  613x534 m² 24,05
-  613x534 m² 24,05
-  200h
-  m² 28,63
-  m³ 0,44
-  2 h
-  2
-  5x 50x50x85h
1x 25x25x85h



Togo è disponibile anche nella versione con montanti in legno

TOAI1002

Togo Jim 2











-  6 - 9
-  176x168x212h
-  534x534 m² 21,7
-  534x534 m² 21,7
-  200h
-  m² 26,38
-  m³ 0,35
-  2 h
-  2
-  4x 50x50x85h



Togo è disponibile anche nella versione con montanti in legno

TOAI1003

Togo Jim 3

-  6 - 9
-  176x89x212h
-  534x455 m² 21,25
-  534x455 m² 21,25
-  200h
-  m² 26,12
-  m³ 0,45
-  2 h
-  2
-  5x 50x50x85h
3x 25x25x85h



Togo è disponibile anche nella versione con montanti in legno



TOAM1001

Pannello Zigulì

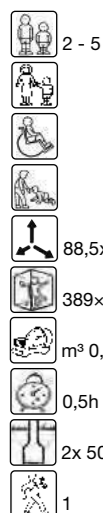

Togo è disponibile anche nella versione con montanti in legno

TOAM1004

Pannello Forme

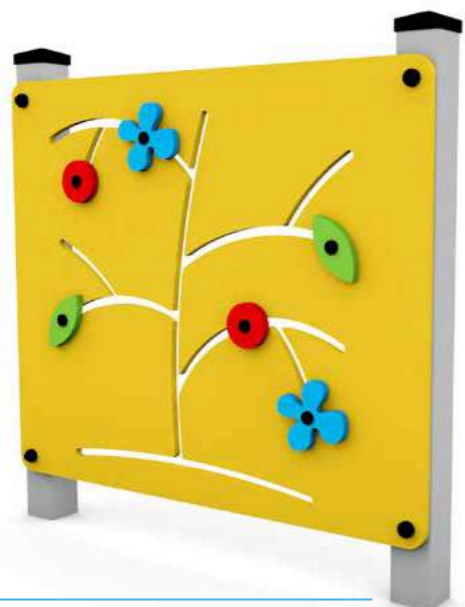
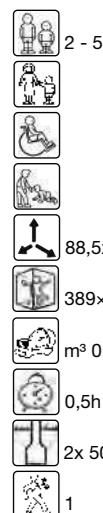

TOAM1002

Pannello attività "Filetto"

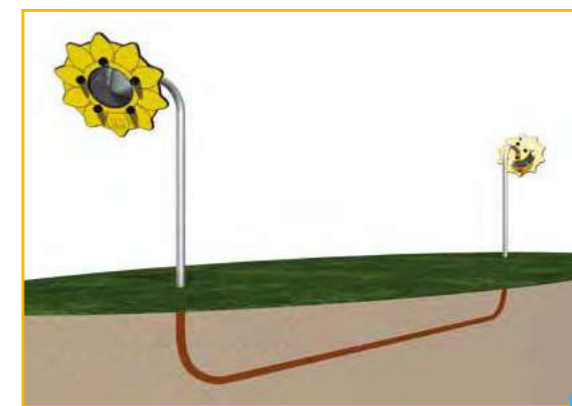
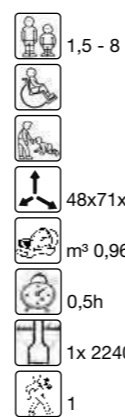
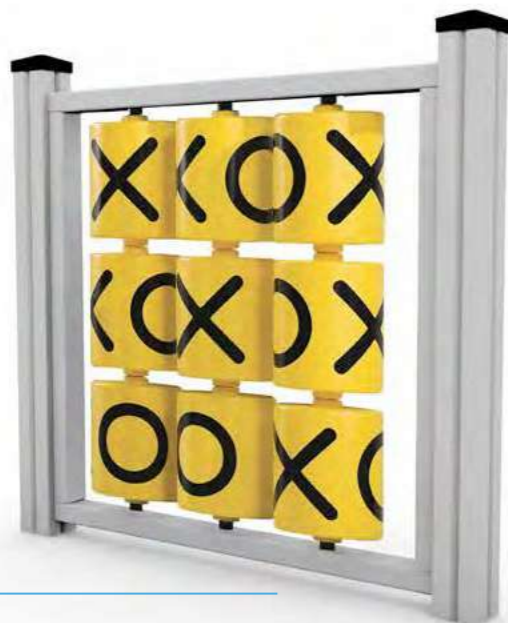

2.815

Tortuga

ARREDO GIOCO

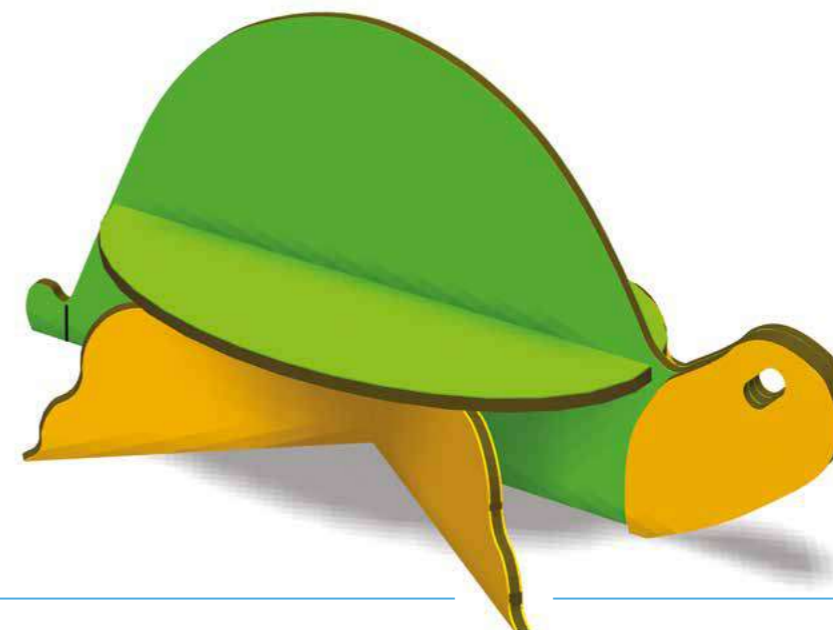

designer: Fabio Casadei

TOAK3101A

Woody

- 1 - 6
- $m^3 0,23$
- 442x74x136h
- 4h
- 742x370 $m^2 25,52$
- 2
- <60h
- 12x 25x25x68h

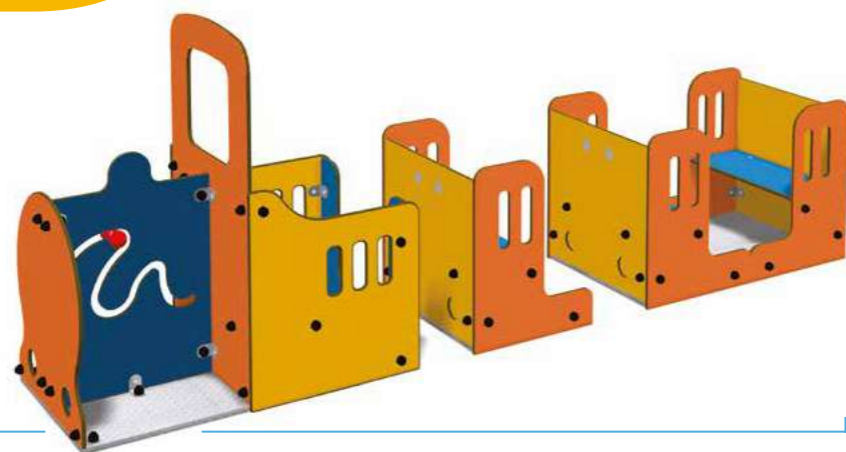

TOAK1101A

Woody 1

- 1 - 6
- $m^3 0,075$
- 166x74x136h
- 1,5h
- 466x370 $m^2 15,31$
- 2
- <60h
- 4x 25x25x68h



TOAK1102A

Woody 2

- 1 - 6
- $m^3 0,075$
- 110x74x66h
- 0,5h
- 410x370 $m^2 13,24$
- 2
- <60h
- 4x 25x25x68h



TOAK1103A

Woody 3

- 1 - 6
- $m^3 0,075$
- 166x74x66h
- 1h
- 466x370 $m^2 15,31$
- 2
- <60h
- 4x 25x25x68h

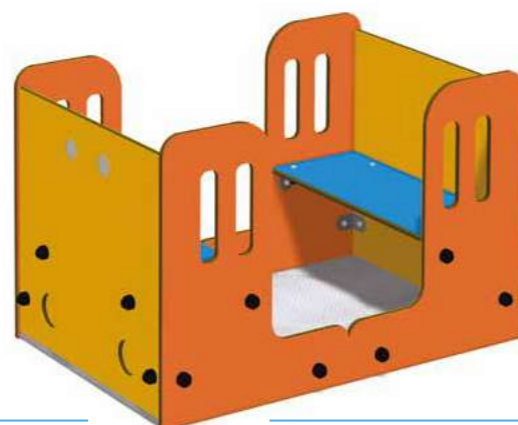

TOAJ1001 Togo House



designer: Fabio Casadei

- 1 - 6
-
- 115x103x150h
- 403x415 m² 15,31

TOAJ1102 Kabana House J1102



-
- 0,5 - 6
-
- 160x135x165h
- 425x456 m² 17,50

TOAJ1103 Kabana House J1103



-
- 0,5 - 6
-
- 160x135x165h
- 425x456 m² 17,50

TOAJ1104 Kabana House J1104

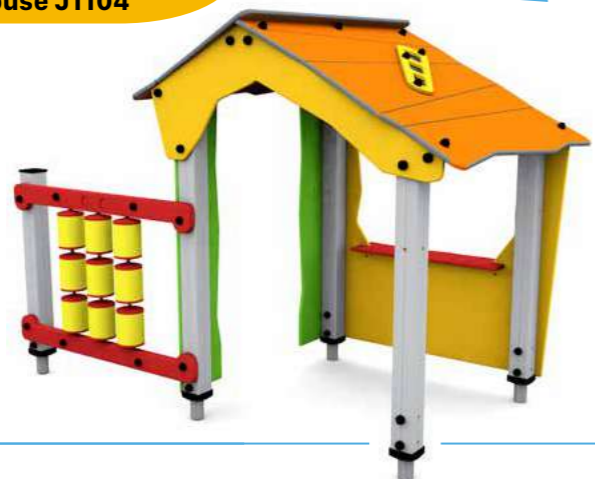

-
- 0,5 - 6
-
- 244x135x165h
- 543x424 m² 19,75

TOAJ1030 Labirinto



Disponibile anche nella versione con montanti in legno

- 1 - 8
-
-
- 440x440x137h
- 740x740 m² 52,85
- <60h

ELEMENTI DI COLLEGAMENTO FRA STANZE GIOCO, PONTICELLI, TUNNEL

2.701/D Frog

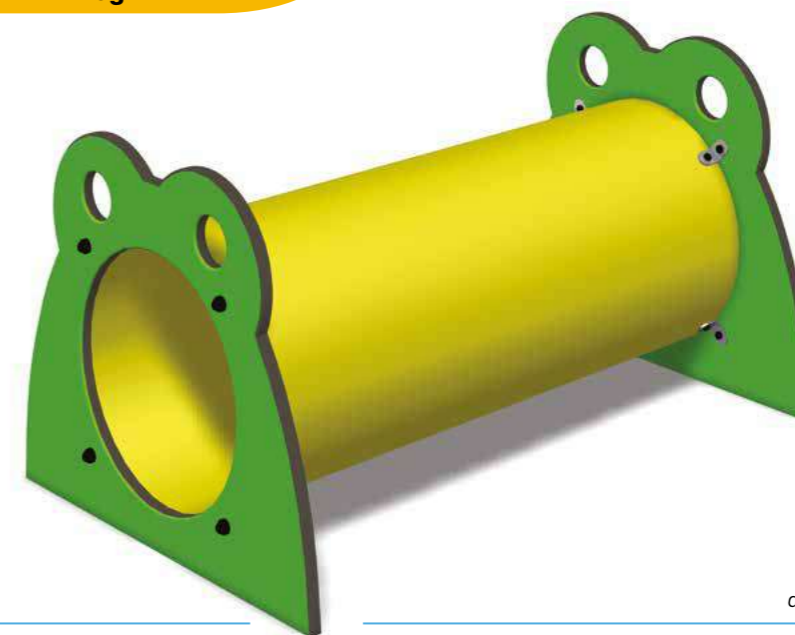

- 1 - 8
-
-
- 108x151x90h
- 407x451 m² 16,43
- m³ 0,19
- 0,5h
- 2
- 4x 40x40x60h

designer: Fabio Casadei

TOAK1104 To-go express

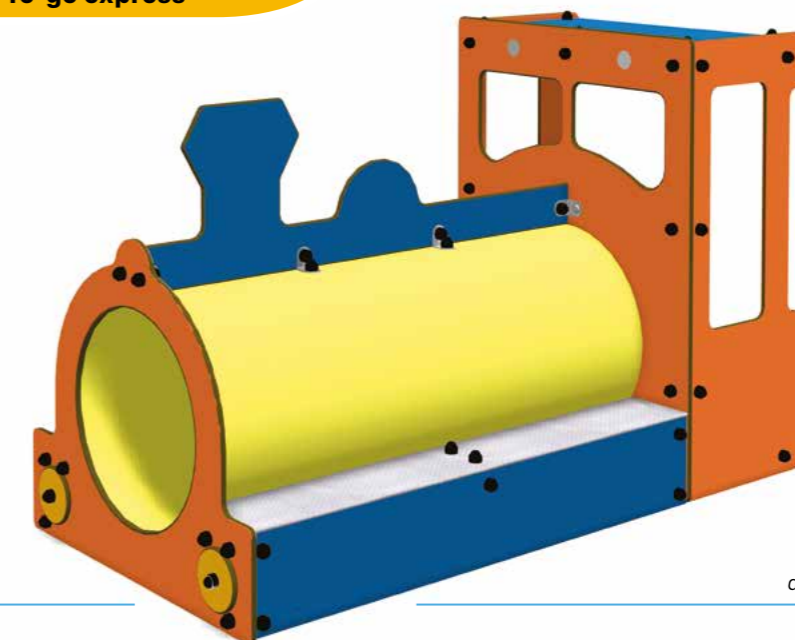

- 1 - 8
-
-
- 97x209x130h
- 398x509 m² 18,33
- m³ 0,19
- 0,5h
- 2
- 4x 40x40x60h

designer: Fabio Casadei



gardenia

*il gioco che agevola l'apprendimento
e lo sviluppo di corpo e mente*



per bambini fino **11**anni

Gardenia è una serie di articoli ludici specificamente progettati per stimolare le attività di esplorazione e scoperta, necessarie per lo sviluppo dei bambini in età prescolare. Gli articoli della serie **Gardenia** offrono ai più piccini la possibilità di scoprire come funzionano le cose, di riuscire a capire i fenomeni naturali, i concetti e i simboli.

L'apprendimento mediante il gioco

Queste attrezzature sono state studiate come supporto e complemento ai programmi prescolari, incentrati sull'apprendimento mediante l'attività ludica.

Gardenia include articoli ludici progettati come sostegno per i bambini ai primi passi, in modo da incoraggiarli a muoversi e sentirsi a proprio agio all'aperto. La fase di progettazione ha tenuto conto dell'antropometria di questi bambini, per assicurarsi che gli appigli per le mani fossero al punto giusto e che, in generale, il prodotto fosse adeguato alla loro corporatura.

Gardenia offre un'ampia varietà di articoli ludici, che permettono una progettazione appropriata degli spazi ludici grazie a moltissime piccole stazioni gioco e aree di esplorazione, che costituiscono il modo migliore di stimolare le attività di apprendimento all'aria aperta. In questo modo i bambini non dovranno mettersi in fila per giocare e non perderanno interesse all'apprendimento, ma

al contrario potranno scegliere le cose che li attraggono maggiormente e, così facendo, si distribuiranno nei singoli spazi ludici che non risulteranno mai troppo affollati.

Cibo per la mente

Gardenia, include tra i suoi articoli giochi con acqua e sabbia, aree per il giardinaggio, che possono essere collocate attorno allo spazio gioco esterno per invitare i bambini a muoversi in tutta l'area. Gardenia rappresenta la scelta ideale per fornire ai bambini spazi di qualità all'aria aperta, in grado di promuovere l'apprendimento e lo sviluppo.

Gardenia dispone di articoli ludici che suscitano la curiosità, incoraggiano i bambini ad esplorare e scoprire cosa riescono a fare e fungono da punti di attrazione e ritrovo per giocare insieme.



**Forme vivaci e colorate
aggiungono un tocco
di giocosità e creano
la suggestione di una
natura animata**



**Gioco di ruolo
e di socializzazione,
apprendimento di
norme sociali e
cooperazione**



**Molte scelte per
l'attività fisica volta
a sviluppare abilità,
muscoli e coordinazione**

**Speciale sistema
di ancoraggio in acciaio
zincato a caldo fissato
al montante tramite
barre filettate incollate
con resine epossidiche**



**Strutture di risalita
e ponti di collegamento
realizzati con
elementi strutturali
in lamellare curvo**



**La lamella superiore
delle sponde degli
scivoli è realizzata
in legno di accoya.
Grazie all'elevata
durezza previene la
formazione di schegge**





GAAA2050L

Gardenia Seasons Asparas



- 2 - 7
- 342x261x354h
- 626x598 m² 31,6
- 626x598 m² 29,10
- 117h
- m² 33
- m³ 0,91
- 7h
- 2
- 10x 50x50x85h
2x 25x25x85h



* Gardenia Seasons è disponibile anche nella versione con scivolo verde in polietilene

GAAA2053L

Gardenia Seasons Bagor



- 2 - 7
- 320x342x405h
- 657x626 m² 34,40
- 657x626 m² 31,67
- 146h
- m² 37
- m³ 0,91
- 5,5h
- 2
- 10x 50x50x85h
2x 25x25x85h



* Gardenia Seasons è disponibile anche nella versione con scivolo verde in polietilene

GAAA2051L Gardenia Seasons Frodo



- 3 - 7
- 370x325x354h
- 655x675 m² 33,7
- 655x613 m² 30,4
- 150h
- m² 36,5
- m³ 0,95
- 8h
- 2
- 10x 50x50x85h
4x 25x25x85h 1x 25x25x75h



* Gardenia Seasons è disponibile anche nella versione con scivolo verde in polietilene

GAAA2055L Gardenia Seasons Deling



- 2 - 8
- 371x428x383h
- 778x655 m² 39,53
- 717x655 m² 36,06
- 155h
- m² 52,5
- m³ 0,606
- 8h
- 2
- 6x 50x50x85h
4x 25x25x85h
1x 25x25x50h



* Gardenia Seasons è disponibile anche nella versione con scivolo verde in polietilene

GAAA2150L Gardenia Seasons Erlina



- 2 - 7
- 438x584x326h
- 715x886 m² 43,65
- 626x574 m² 29,14
- 88,5h
- m² 32
- m³ 1,70
- 10,5h
- 2
- 19x 50x50x85h
2x 25x25x85h



* Gardenia Seasons è disponibile anche nella versione con scivolo verde in polietilene

GAAA2152L Gardenia Seasons Celin













- 5 - 11
- 477x346x282h
- 726x907 m² 48,9
- 726x907 m² 48,5
- 150h
- m² 49
- m³ 0,9498
- 11h
- 2
- 10x 50x50x85h
4x 25x25x85h



* Gardenia Seasons è disponibile anche nella versione con scivolo verde in polietilene

GAAA3150L **Gardenia Seasons Gleviel**

-  2 - 11
-  632x350x383h
-  982x640 m² 46,94
-  893x635 m² 42,15
-  150h
-  m² 50
-  m³ 1,306
-  13h
-  2
-  14x 50x50x85h
4x 25x25x85h 1x25x25x50h



* Gardenia Seasons è disponibile anche nella versione con scivolo verde in polietilene



GAAA1150L

Gardenia Seasons Galdor



- 2 - 7
- 279x371x354h
- 721x546 m² 28,4
- 659x546 m² 24,79
- 117h
- m² 30
- m³ 0,65
- 5,5h
- 2
- 7x 50x50x85h
2x 25x25x85h

GAAA1150P*



* Gardenia Seasons è disponibile anche nella versione con scivolo verde in polietilene



GAAA1001L

Gardenia Seasons Sindarin



- 2 - 7
- 185x228x171h
- 574x478 m² 21,8
- 574x421 m² 18,6
- 88,5h
- m² 22
- m³ 0,56
- 4h
- 2
- 6x 50x50x85
2x 25x25x85

GAAA1001P*



* Gardenia Seasons è disponibile anche nella versione con scivolo verde in polietilene



GAAA1152L

Gardenia Seasons Delarith



- 2 - 7
- 320x322x326h
- 621x666 m² 29,39
- 653x492 m² 23,93
- 88,5h
- m² 29,5
- m³ 0,6508
- 7h
- 2
- 12x 40x40x60h
4x 25x25x85h

GAAA1152P*



* Gardenia Seasons è disponibile anche nella versione con scivolo verde in polietilene



GAAA1003L

Gardenia Seasons Tilin



- 2 - 7
- 250x312x228h
- 543x657 m² 27,15
- 479x657 m² 23,37
- 146h
- m² 29
- m³ 0,32
- 3h
- 2
- 6x 50x50x60h
2x 25x25x60h

GAAA1003P*



* Gardenia Seasons è disponibile anche nella versione con scivolo verde in polietilene

GAAA1050L **Gardenia Seasons Gilfamon**



- 2 - 7
- 185x237x326h
- 574x478 m² 21,8
- 574x421 m² 8,65
- 88,5 h
- m² 22,5
- m³ 0,56
- 4,5h
- 2
- 6x 50x50x85h
2x 25x25x85h

GAAA1050P*



* Gardenia Seasons è disponibile anche nella versione con scivolo verde in polietilene



GAAA1052L **Gardenia Seasons Glorin**



- 2 - 7
- 250x320x405h
- 543x660 m² 27,68
- 479x660 m² 24,31
- 146h
- m² 29
- m³ 0,56
- 4,5h
- 2
- 6x 50x50x85h
2x 25x25x85h

GAAA1052P*



* Gardenia Seasons è disponibile anche nella versione con scivolo verde in polietilene

GAAE1101D

Tania D



- 2,5+
- 209x47x280h
- 710x370 m² 17,07
- 200x667 m² 13,4
- <100h
- m² 12,5
- m³ 0,12
- 1h
- 2
- 2x 50x40x60h

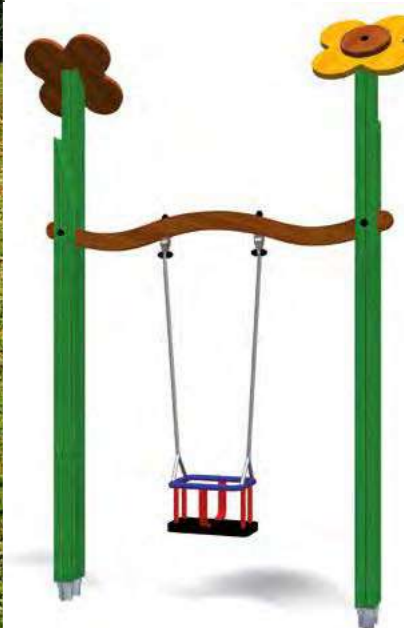

GAAE1101C

Tania C



- 2,5+
- 209x47x280h
- 710x370 m² 17,07
- 200x667 m² 13,4
- <100h
- m² 12,5
- m³ 0,21
- 1h
- 2
- 2x 60x50x60h

GAAE1101E

Tania E









- 0,5 - 2,5
- 209x47x280h
- 710x370 m² 17,07
- 200x667 m² 13,4
- <100h
- m² 12,5
- m³ 0,21
- 1h
- 2
- 2x 60x50x60h

GAAH1101

Deli













-  3 - 8
-  47x38x27h
-  400x400 m² 16
-  m³ 0,0875
-  0,2h
-  1
-  1x 50x50x75h

ATTREZZI GINNICI E DI EQUILIBRIO

GAAI1101

Elanor









-  3 - 8
-  m² 20
-  201x181x281h
-  m³ 0,35
-  468x468 m² 16,50
-  1,5h
-  468x468 m² 16,50
-  2
-  <99h
-  4x 50x50x85h

GAAI1104





Dela



-  3 - 8
-  47x38x27h
-  336x346 m² 9,15
-  0,2h
-  1
-  1x 50x50x75h

GAAI1103





Dola

-  1+
-  47x38x27h
-  336x346 m² 9,15
-  1x 50x50x75h



GAAI1104







Dela

-  1+
-  47x38x27h
-  336x346 m² 9,15
-  1x 50x50x75h



GAAI5101



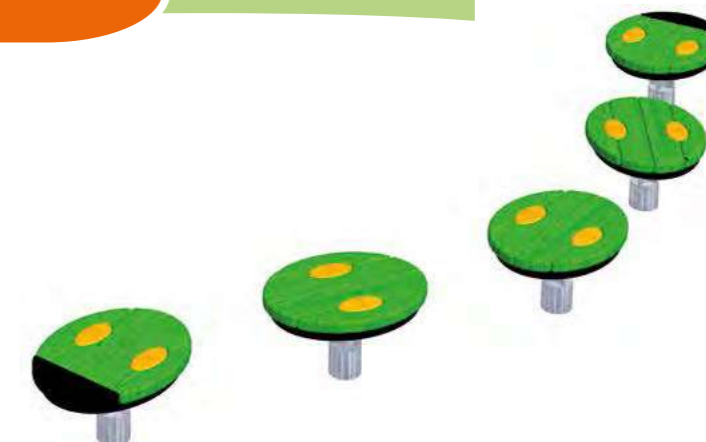

Pigor

-  1+
-  310x108x27h
-  407x610 m² 18,71
-  m³ 0,4375
-  1h
-  5x 50x50x75h



GAAA1104Z



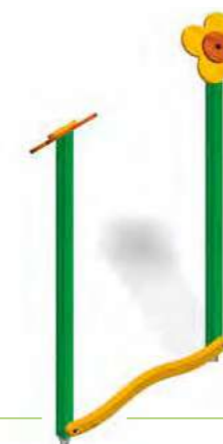

Gardenia Seasons Foster

-  2 - 7
-  38x206x303h
-  315x368 m² 12,80
-  2x 50x50x85h



GAAA1105Z







Gardenia Seasons Feldor

-  2 - 7
-  35x187x281h
-  315x468 m² 12,50
-  1x 50x50x85h



GAAA8801Z

Gardenia Seasons Prilla

-  2 - 7
-  35x98x29h
-  335x400 m² 10,55
-  m³ 0,17
-  1h
-  1
-  2x 50x50x85h



Vedi anche: Snake p.173 Traballo p. 199



1.740 **Champignon 55h**

1.740/B **Blu**
1.740/G **Giallo**
1.740/R **Rosso**

- 1 - 6
-
-
- Ø50x55h



1.741 **Champignon 65h**

1.741/B **Blu**
1.741/G **Giallo**
1.741/R **Rosso**

- 1 - 6
-
-
- Ø50x65h



1.742 **Champignon 75h**

1.742/B **Blu**
1.742/G **Giallo**
1.742/R **Rosso**

- 1 - 6
-
-
- Ø50x75h



1.744 **Blob**



- 1+
-
-
- Ø50x25h
- m³ 0,04
- 1x 40x40x40h

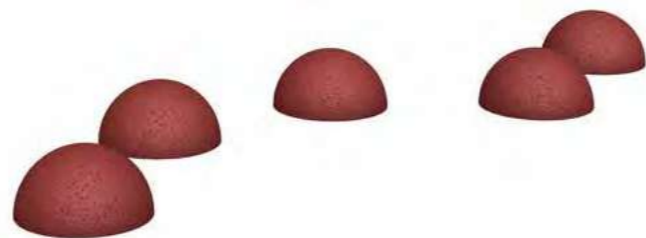

Balls

1.791 **Sfera Ø500**
1.791/A **Mezza sfera Ø500**



Stepper

1.795/B **Stepper h 30**
1.795/C **Stepper h 40**
1.795/D **Stepper h 50**



Girasole

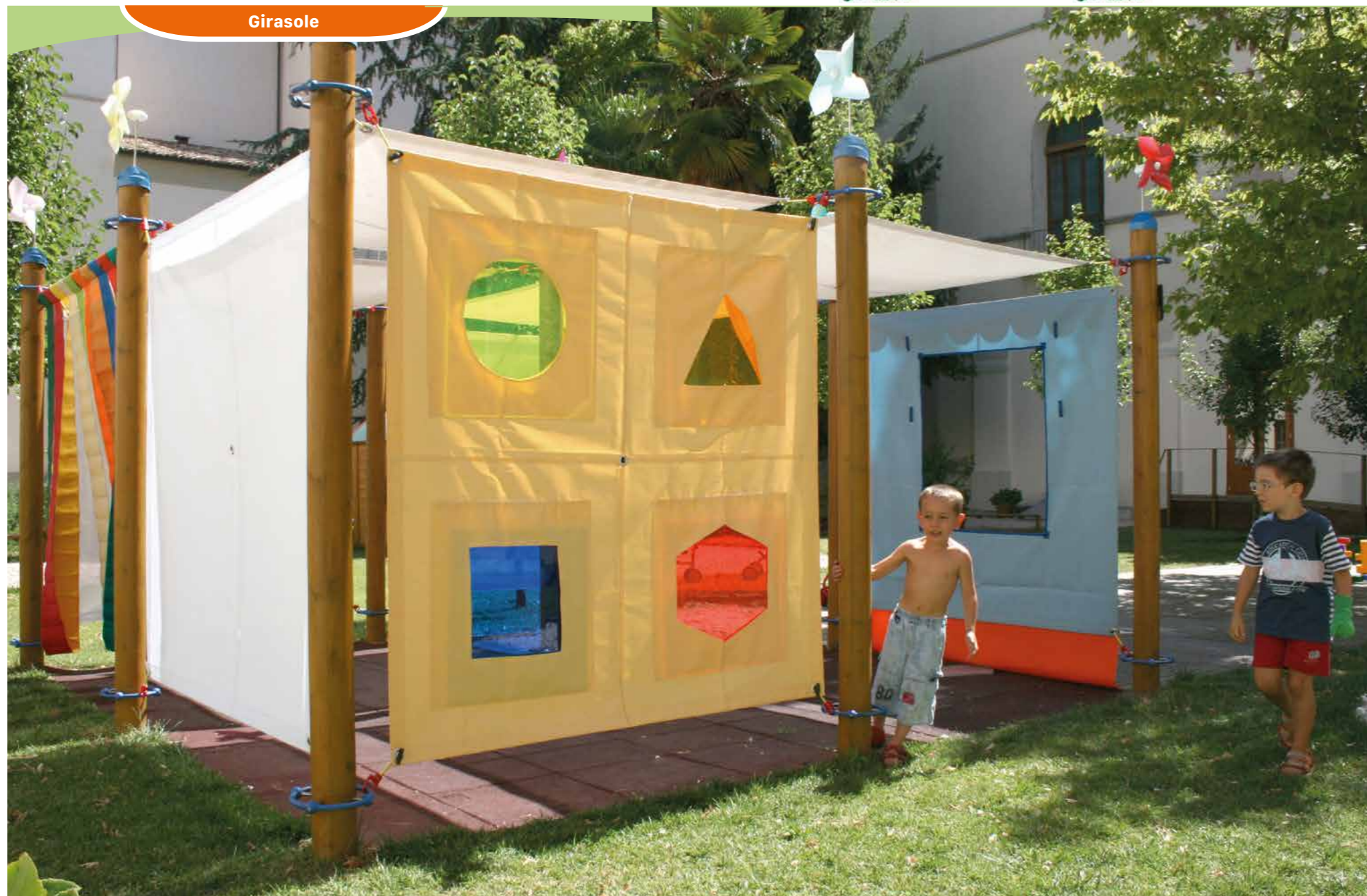

2.470/A

Girasole 9 pali e 6 teli

La foto mostra i pannelli aggiuntivi del pergolato Girasole 2.470/A

0,5 - 10

400x400x263h

 716x716 m² 49,31

 m³ 0,43

2h

2

9x 50x50x85h



designer: Fabio Casadei

2.470

Girasole 9 pali

0,5 - 10

400x400x263h

 716x716 m² 49,31

 m³ 0,43

1,5h

2

9x 50x50x85h

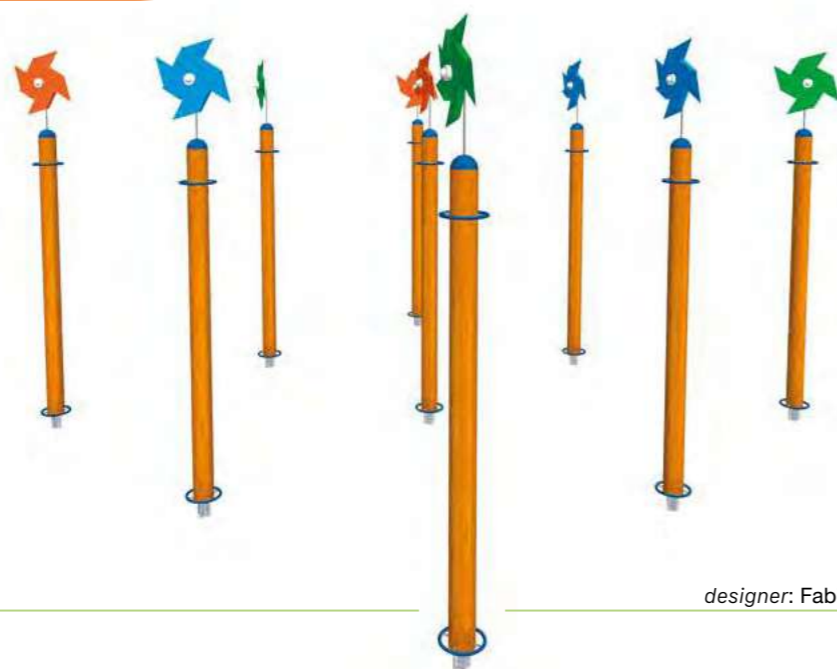

designer: Fabio Casadei

MRC004ASOIBE

Sabbiera 4A

0,5 - 6

150x150x34h

 439x439 m² 17,32

 m³ 0,06

1h

2

4x 25x25x40h

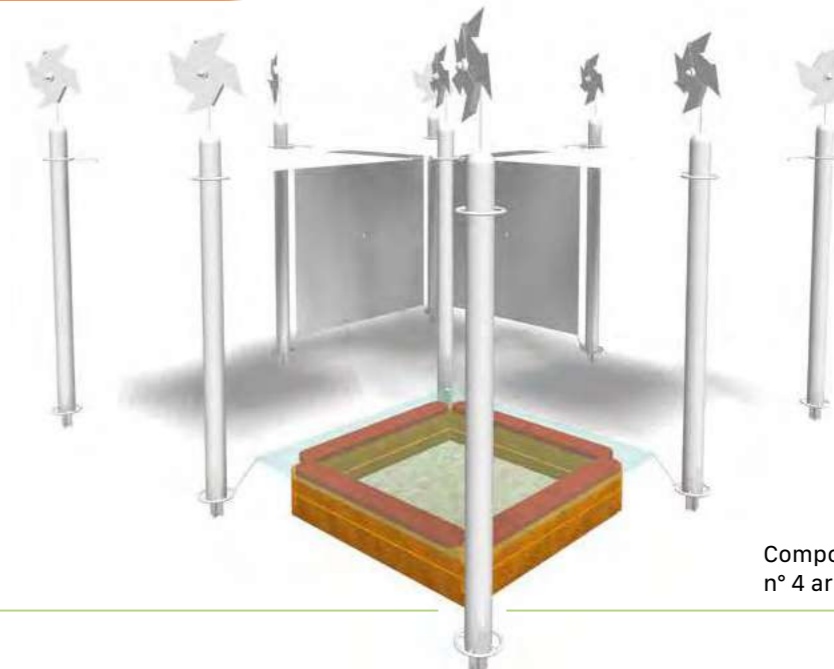
Composto da:
n° 4 art. MRE001SOIPE

2.481

Telo bianco microforato Girasole



designer: Fabio Casadei

168x168

2.482

Teatrino Girasole

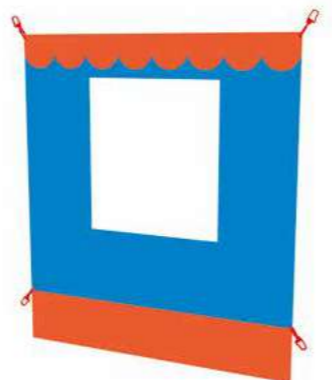

designer: Fabio Casadei

168x201

2.483

Tasche Girasole

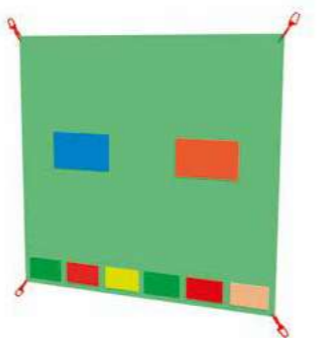

designer: Fabio Casadei

168x168

2.484

Arcobaleno Girasole



designer: Fabio Casadei

150x190

2.485

Forme trasparenti Girasole

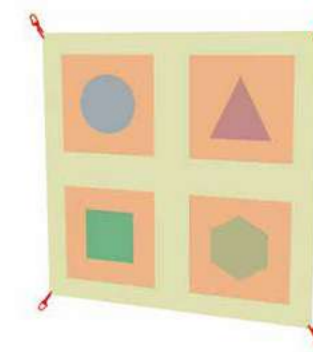

designer: Fabio Casadei

168x168

2.480/F

Palo Girasole con girandola rosa



designer: Fabio Casadei

Colori disponibili

- A - Violetto
- B - Rosso
- C - Arancio
- D - Giallo
- E - Verde
- F - Rosa
- G - Verde acqua
- H - Blu chiaro
- I - Blu

0,5 - 10



Ø24x263h

324x324 m² 8,12

m³ 0,07

0,1h

1

1x 50x50x85h

2.487

Sombbrero Girasole



368x368x2h

designer: Fabio Casadei

SKC0001S0IWE

Basic Souk®



- 0,5 - 9
-
-
-
- 154x154x154h
- 454x454 m² 18,52
- 1,5h
- 2



designer: Fabio Casadei

SKC0003S0IWE

Souk® percorso sensoriale



- 0,5 - 9
-
-
-
- 710x568x154h
- 5h
- 1022x880 m² 58,31
- 2



designer: Fabio Casadei

SKC0002S0IWE

Souk® Sabbia



- 0,5 - 9
-
-
-
- 426x426x162h
- 6h
- 737x737 m² 52,18
- 2

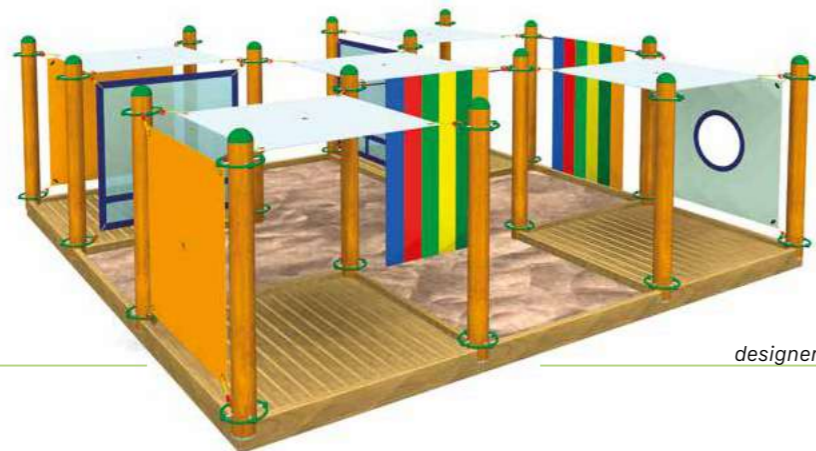

designer: Fabio Casadei

SKC0004S0IWE

Stanza gioco Souk®



- 0,5 - 9
-
-
-
- 284x284x154h
- 3h
- 596x596 m² 33,43
- 2



designer: Fabio Casadei



SKE0001SOIWE Montante per Souk®

0,5 - 9
 Ø12x140 cm
 0,2h
 1

SKE0014SJIPE Montante per Souk® con plinto da 855 mm

0,5 - 9
 Ø12x157 cm
 0,2h
 1
 m³ 0,0875
 1x 50x50x85h

SKE0014SKIPE Montante per Souk® con plinto da 150 mm

0,5 - 9
 Ø12x157 cm
 0,2h
 1

SKE0014SWIPE Montante per Souk® con plinto da 600 mm

0,5 - 9
 Ø12x157 cm
 0,2h
 1
 m³ 0,075
 1x 50x50x60h

SKE0006SOIPE Sabbiera Souk®

0,5 - 9
 149,5x149,5x14,5h

SKE0013SOZQE Telaio in ferro per Souk®

0,5 - 9
 140,5x140,5x7h

SKE0003SOIPE Piano sabbiera per Souk®

0,5 - 9
 140,5x140,5x10,7h

SKE0004SOIPE Piano per inserimento elemento gioco sensoriale Souk®

0,5 - 9
 140,5x140,5x10,7h

SKE0002SOIPE Piano in legno per Souk®

0,5 - 9
 140,5x140,5x10,7h

SKE0007SOIPE Raccordo sabbiera Souk®

0,5 - 9
 131,6x14,5x4,5h



1.870/SRK TLF Tile 50x50x3

0,5 - 9
 50x50x3h
 Necessarie 4 mattonelle

SKE0005S00CE Kit tappeto sensoriale Souk®

0,5 - 9
 100x100x1,5h

SKE0008S00SE Telo bianco Souk®

0,5 - 9
 110x110cm

SKE0009S00SE Telo arancio Souk®

0,5 - 9
 110x110cm

SKE0010S00SE Telo arcobaleno Souk®

0,5 - 9
 110x132cm

SKE0011S00SE Telo trasparente Souk®

0,5 - 9
 110x110cm

SKE0012S00SE Telo forato Souk®

0,5 - 9
 110x110cm

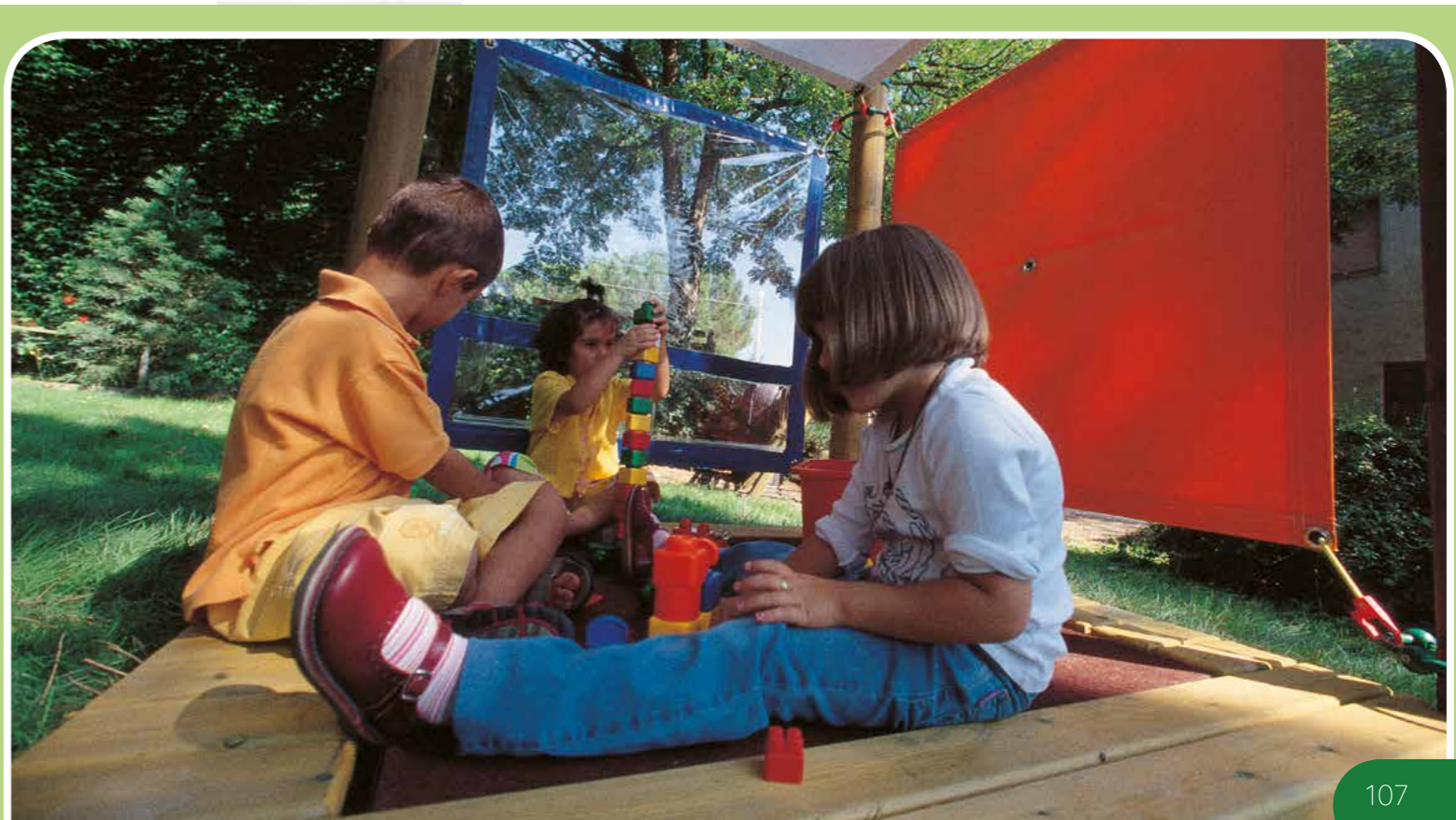

2.825/A

Mercatino Ninetta

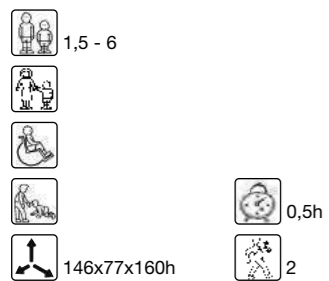

designer: Fabio Casadei

2.825/C

Seduta Ninetta

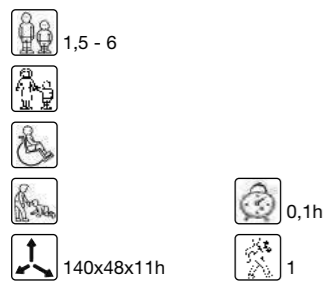

designer: Fabio Casadei

2.825/D

Ninetta Primipassi

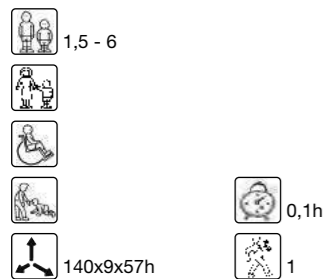

designer: Fabio Casadei

2.825/E

Teatrino Ninetta

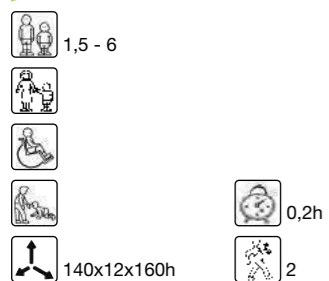

designer: Fabio Casadei

2.825/F

Ninetta Piccolo

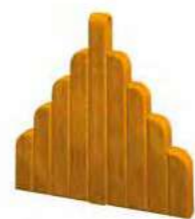
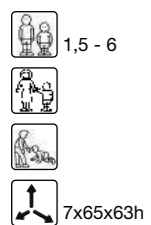

designer: Fabio Casadei

2.825/G

Ninetta Primipassi curva esterna



designer: Fabio Casadei

2.825/H

Ninetta Primipassi curva interna



designer: Fabio Casadei

2.825/B

Ninetta Bonanza

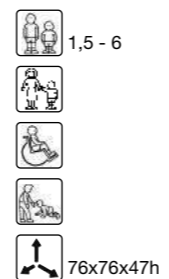

designer: Fabio Casadei

2.825/I

Coperchio per Ninetta Bonanza

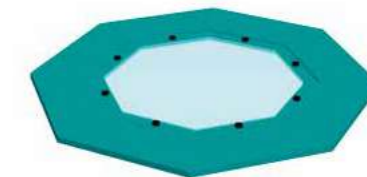
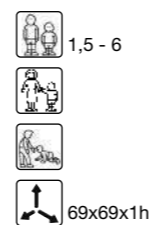

designer: Fabio Casadei

Composizione 1

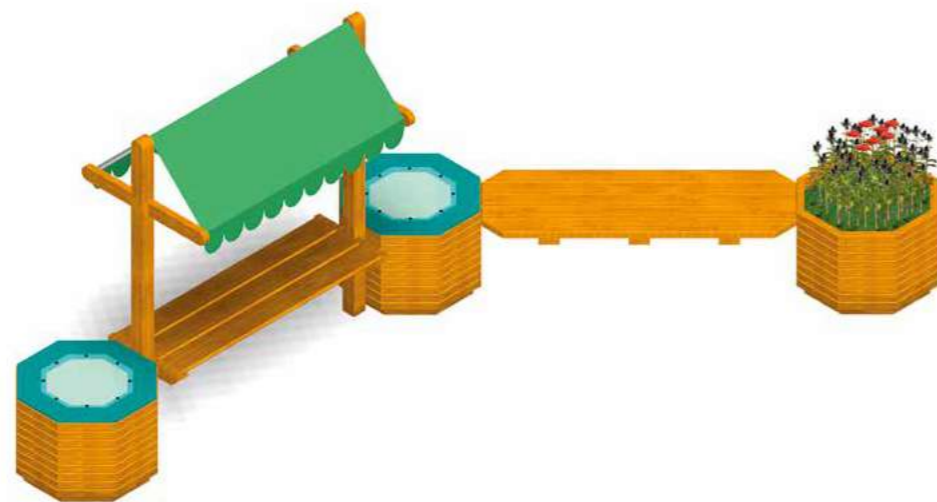

- 2.825/A pz 1 **Mercatino Ninetta**
 2.825/B pz 3 **Ninetta Bonanza**
 2.825/C pz 1 **Seduta Ninetta**
 2.825/I pz 2 **Coperchio per Ninetta Bonanza**

Composizione 2



- 2.825/A pz 1 **Mercatino Ninetta**
 2.825/B pz 4 **Ninetta Bonanza**
 2.825/C pz 1 **Seduta Ninetta**
 2.825/D pz 1 **Ninetta Primipassi**
 2.825/I pz 2 **Coperchio per Ninetta Bonanza**

Composizione 3



- 2.825/A pz 1 **Mercatino Ninetta**
 2.825/B pz 5 **Ninetta Bonanza**
 2.825/C pz 1 **Seduta Ninetta**
 2.825/E pz 1 **Teatrino Ninetta**
 2.825/G pz 1 **Ninetta Primipassi curva esterna**
 2.825/I pz 2 **Coperchio per Ninetta Bonanza**



2.821

Anfiteatro dei Popoli a 3 elementi



1 - 8



577x208x243h

 877x508 m² 34,12

 m³ 0,30

2

2h

16x 25x25x40h



designer: Fabio Casadei

2.822

Anfiteatro dei Popoli a 4 elementi



1 - 8



688x276x246h

 m³ 0,37

2,2h

2

 987x576 m² 40,84

20x 25x25x40h



designer: Fabio Casadei

Vedi anche: **3 Tri** p. 174

2.823

Anfiteatro dei Popoli a 5 elementi

1 - 8



778x327x246h

 1078x626 m² 48,79

 m³ 0,45

2,3h

2

24x 25x25x40h



designer: Fabio Casadei

2.821/A

Pedana per Anfiteatro dei Popoli a 3 elementi

1 - 8



363x271x6h

 421x663 m² 24,44

designer: Fabio Casadei

2.822/A

Pedana per Anfiteatro dei Popoli a 4 elementi

1 - 8



464x217x6h

 765x367 m² 20,78

designer: Fabio Casadei

2.823/A

Pedana per Anfiteatro dei Popoli a 5 elementi

1 - 8



464x217x6h

 808x421 m² 25,02

designer: Fabio Casadei



2.830

Agorà a 3 elementi

Altezza seduta 35h

630x195x192h

m³ 0,30

2h

2

16x 25x25x40h

2.832

Altezza seduta 45h

630x195x222h



2.831

Agorà a 3 elementi con copertura

Altezza seduta 35h

665x224x317h

m³ 0,30

2h

2

16x 25x25x40h

2.833

Altezza seduta 45h

665x224x347h



2.830/A

Pedana per Agorà rettangolare

600x400x6h



2.834

Agorà a 3 elementi semicircolare

Altezza seduta 35h

852x297x193h

m³ 0,30

2h

2

16x 25x25x40h

2.836

Altezza seduta 45h

852x297x223h



2.835

Agorà a 3 elementi semicircolare con copertura

Altezza seduta 35h

908x329x317h

m³ 0,30

2h

2

16x 25x25x40h

2.837

Altezza seduta 45h

908x327x347h



2.834/A

Pedana per Agorà semicircolare

550x400x6h



Vedi anche: [Telo acrilico per pergolato](#) p.118

2.806

Mindy

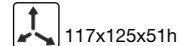

2.806/C

Benni

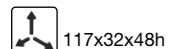

2.806/D

Andy

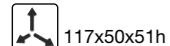
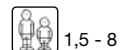

2.809

Sedia Cantastorie

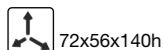

Vedi anche: **Prilla**

p. 97

Pic-nic Vieste

p. 252

Ninetta Bonanza

p. 109



2.804/A01

Tavolo Tasto



2.804/A02

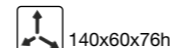

2.804/B01

Panca Asta

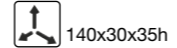

2.804/B02



2.804/D02

Tavolo Tasto Quadrato

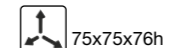

2.804/D01

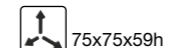

2.804/C01

Sgabello Asto

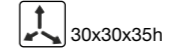

2.804/C02

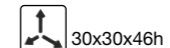

3.127

Panchina Mezza

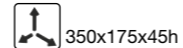

Vedi anche: **Pergolati**

p. 118



3.420/A

Pergolato base

- 300x300x227h
- m³ 0,19
- 2h
- 2
- 4x 40x40x60h



3.421/A

Pergolato doppio

- 600x300x227h
- m³ 0,28
- 3h
- 2
- 6x 40x40x60h



Moduli composti

3.420/B
formato da 4
moduli base

- 600x600x227h

3.420/C
formato da 9
moduli base

- 900x900x227h

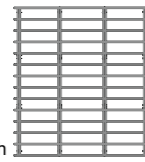
3.421/B
formato da 6
moduli base

- 600x900x227h

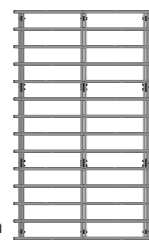
3.422/A
formato da 3
moduli base
ad angolo

- 600x600x227h



3.460

Telo acrilico per pergolato

- 120x100cm



GAEK3101Z

Rocket Train



designer: Fabio Casadei

GAEK1101Z

Rocket Locomotiva

- 0,5 - 8
-
- 80x116x68h
- 380x416 m² 14
- <60h
- h
- 4x 50x50x85h

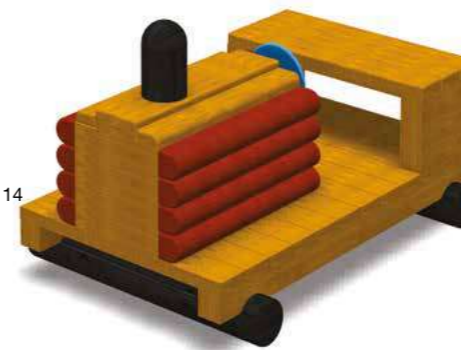

designer: Fabio Casadei

GAEK1102Z

Rocket Vagone

- 0,5 - 8
-
- 80x116x45h
- 380x416 m² 14
- <60h
- h
- 4x 50x50x85h

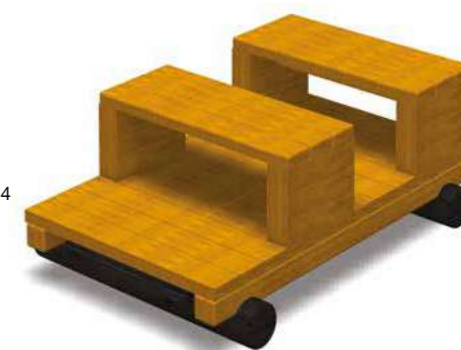

designer: Fabio Casadei



2.915 **Brucosauro**

110x132cm

2.916 **Lumasauro**

110x110cm

2.901 **Ceppo di legno**

2.902 Ø30x20cm

2.903 Ø30x30cm

Ø30x40cm

2.917 **Collina in ceppi di legno**

90x60x30h cm

2.918 **Corona in ceppi di legno**

90x60x30h cm

2.911 **Sauro**

90x60x30h cm

2.912 **Bisauro**

90x60x30h cm

2.913 **Trisauro**

90x60x30h cm

2.914 **Motosauro**

100x60x45h cm











2.412/B Villaggio Primavera B

-  0,5 - 6
- 
- 
-  322x262x225h
-  607x554 m² 28,93
-  4h
-  2



designer: Fabio Casadei







2.412/A Villaggio Primavera A

-  0,5 - 6
- 
- 
-  323x220x189h
-  608x504 m² 26,14
-  3,5h
-  2



designer: Fabio Casadei







2.412/C Villaggio Primavera C

-  0,5 - 6
- 
- 
-  323x220x224h
-  607x505 m² 27,46
-  4,5h
-  2



designer: Fabio Casadei

2.412/D Villaggio Primavera D

-  0,5 - 6
- 
- 
-  115x219x189h
-  409x504 m² 18,47
-  3h
-  2



designer: Fabio Casadei

2.411/B



Pedana per Villaggio Primavera

2.411/D



Fioriera per villaggio Primavera

2.411/E



Palo con girandola

2.411/C



Recinzione Villaggio Primavera

2.411/F



Montante Primavera 60 h

2.411/A

Cottage Primavera

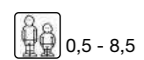

0,5 - 8,5



116x122x189h

402x402 m² 14,22

1,5h

2



2.411/G

Cottage Primavera G

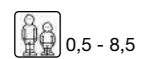

0,5 - 8,5



116x122x189h

419x416 m² 15,51m³ 0,04

2x 25x25x30



2.411/H

Cottage Primavera H

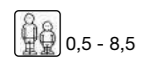

0,5 - 8,5



116x122x189h

419x416 m² 15,51m³ 0,04

2x 25x25x30



2.411/I

Cottage Primavera I

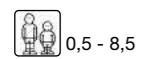

0,5 - 8,5



116x122x189h

419x416 m² 15,51m³ 0,04

2x 25x25x30



2.411/L

Cottage Primavera L

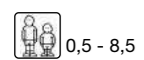

0,5 - 8,5



116x122x189h

419x416 m² 15,51m³ 0,04

2x 25x25x30



2.413/A

Friends House A



0,5 - 8

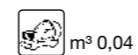
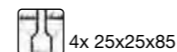

153x153x200h

m³ 0,04

4x 25x25x85



1,5h



2

453x453 m² 18,60

2.413/B

Friends House B

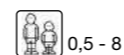

0,5 - 8

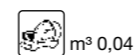
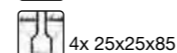

153x153x200h

m³ 0,04

4x 25x25x85



1,5h



2

453x453 m² 18,60

2.413/D

Friends House D

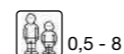

0,5 - 8

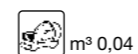
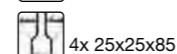

153x153x200h

m³ 0,04

4x 25x25x85



1,5h



2

453x453 m² 18,60



2.421/A

Capanna



194x190x192h

494x481 m² 21,81m³ 0,19

1,5h



4x 40x40x60h

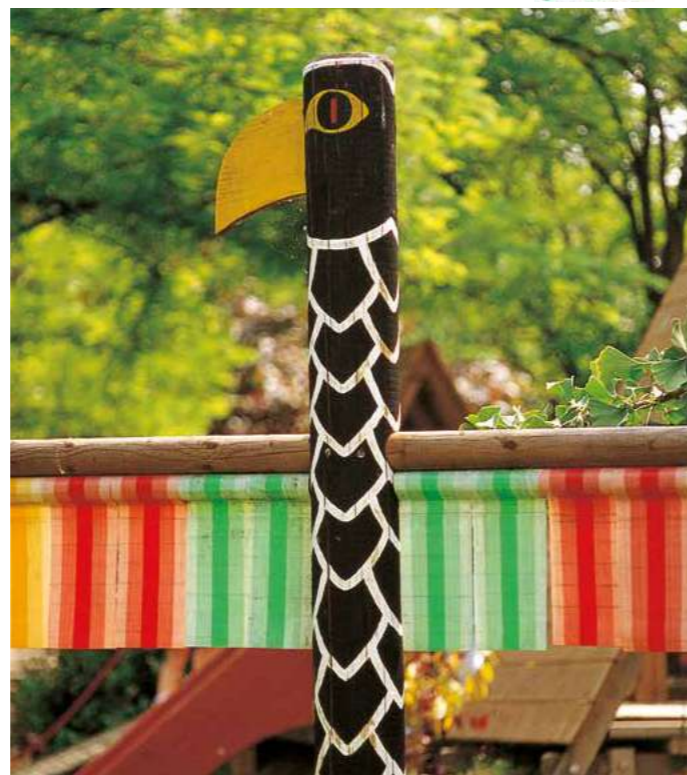
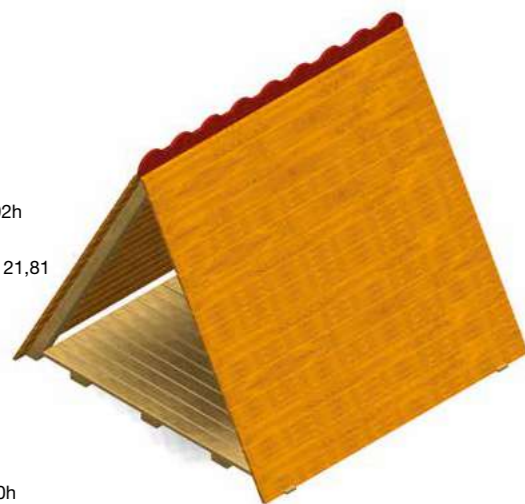

2.421/B

Capanna B



194x187x192h

494x481 m² 21,81m³ 0,19

1h



4x 40x40x60h

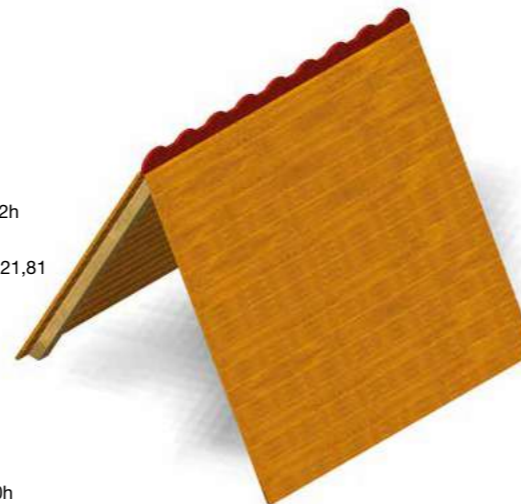

2.423

Capanna C



181x245x209h

545x481 m² 23,87m³ 0,28

2h



6x 40x40x60h



1.711

Totem

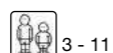

190x14x240h

Ø314 m² 7,74m³ 0,1

1x 50x50x70h



2.765

Locanda



221x213x165h

502x495 m² 22,97

4h



2



designer: Fabio Casadei



2.890

Ponticello Rimini

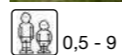

249x110x96h

549x405 m² 20,32



designer: Fabio Casadei

2.762

Garagino 1



221x213x202h

503x496 m² 22,99

4h

2



designer: Fabio Casadei

2.763

Garagino 2



221x107x202h

496x402 m² 18,02

2,5h

2



designer: Fabio Casadei

2.701/E

Galleria

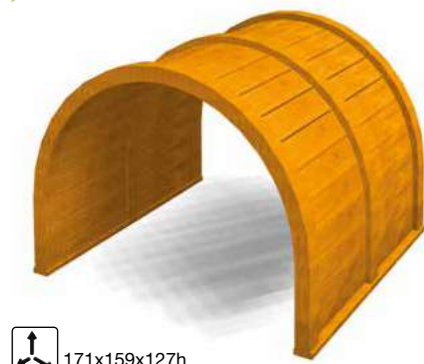

171x159x127h

2.760

Gasoline con pedana

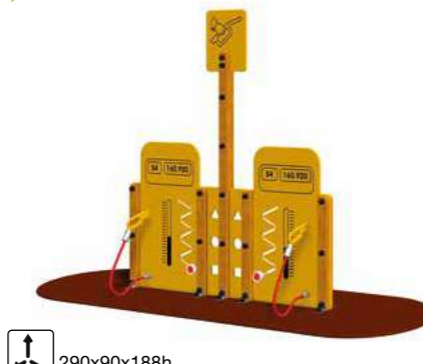

290x90x188h

2.764

Scaffalatura

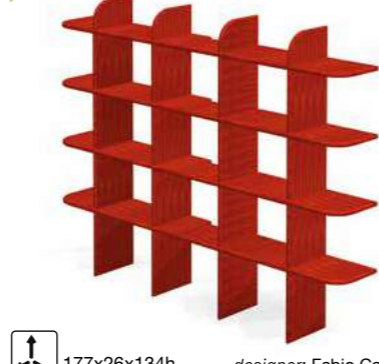

177x26x134h

designer: Fabio Casadei

GIOCO DI MANIPOLAZIONE E SENSORIALE

2.715

Mozart con pedana



Ø91x99h

Ø391 m² 12,01

0,2h

1



2.715/B

Mozart



46x11x96h

342x307 m² 8,56

m³ 0,01

0,2h

1

1x 25x25x60h



designer: Fabio Casadei

2.716

Pit-stop

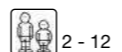

Ø59x80h

Ø359 m² 10,12

m³ 0,04

1x 40x40x60h

2.716/B Palo pit-stop
2.716/C Copertone blu
2.716/D Copertone giallo
2.716/E Copertone rosso
2.716/F Copertone verde



designer: Fabio Casadei

La sabbia è un fantastico strumento per i più piccoli: permette loro di realizzare un'infinità di cose, tanto da rimanerne affascinati per lunghi periodi.

TLF soddisfa queste esigenze con la serie **Miraggi®**, un nuovo sistema di sabbiere semplici da assemblare, per creare un'area per il gioco con sabbia che risponda perfettamente alle esigenze dei bambini che la utilizzeranno, adattandosi al contempo in modo ideale allo spazio disponibile.

Questi elementi sono in grado di rispondere in modo puntuale alle esigenze ambientali di ogni sito, offrendo soluzioni frangivento ed ombreggianti, grazie alla possibilità di ordinare moduli con bordi appositamente rialzati. I moduli più alti potranno essere anche utilizzati come sostegno per la seduta di bambini con disabilità. I moduli sono realizzati con legnami accuratamente selezionati. I bambini li troveranno pertanto comodi e invitanti al tatto.



I moduli per costruire Miraggi®

Gli elementi delle sabbiere sono studiati per essere facili da connettere e formare una struttura sicura e resistente. Ogni modulo include una barra filettata passante di congiunzione e plinti di ancoraggio a terra.

MRE0001SOIPE



Pannello Miraggi (cm 140x34)

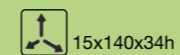

MRE0004SOIPE

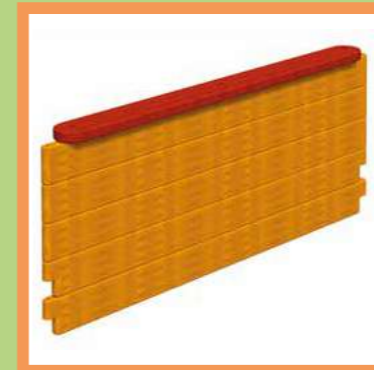

Pannello Miraggi (cm 190x77) da installare con 2 pannelli cm 34h

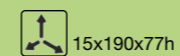

MRE0007SOIPE



Pannello Miraggi cm 140x77 da installare con 2 pannelli cm 77h

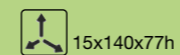

MRE0002SOIPE



Pannello Miraggi (cm 190x34)

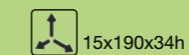

MRE0005SOIPE

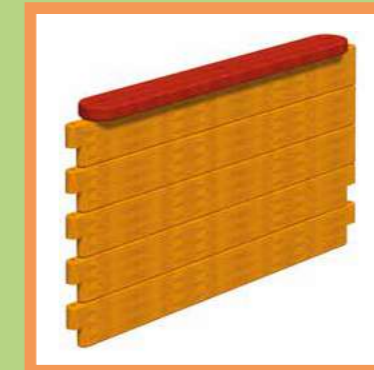

Pannello Miraggi (cm 140x77) da installare con 1 pannello cm 77h e 1 cm 34h

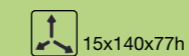

MRE0008SOIPE



Pannello Miraggi cm 190x77 da installare con 2 pannelli cm 77h

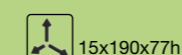

MRE0009SOIPE

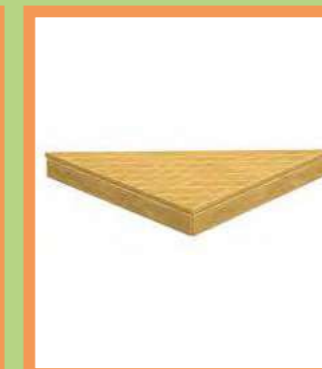

Piano triangolare Miraggi

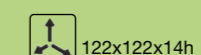

MRE0003SOIPE



Pannello Miraggi (cm 140x77) da installare con 2 pannelli cm 34h

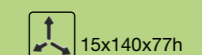

MRE0006SOIPE



Pannello Miraggi (cm 190x77) da installare con 1 pannello cm 77h e 1 cm 34h

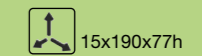

MRE0010SOIPE



Kit per fissaggio pannelli Miraggi h 77

MRC001ASOIFE

Sabbiera 1A



- 0,5 - 6
- 200x200x34h
- 489x489 m² 21,95
- m³ 0,06
- 1
- 2
- 4x 25x25x40h



MRC001BSOIFE

Sabbiera 1B



- 0,5 - 6
- 386x200x34h

MRC002ASOIFE

Sabbiera 2A



- 0,5 - 6
- 286x286x34h

MRC004ASOIFE

Sabbiera 4A



- 0,5 - 6
- 150x150x34h

MRE0011SOIFE

Rete antintrusione per sabbiera 1A

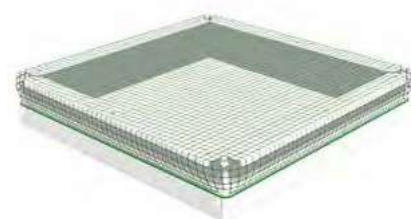

- 220x220

MRE0014SOIFE

Rete antintrusione per sabbiera 1B

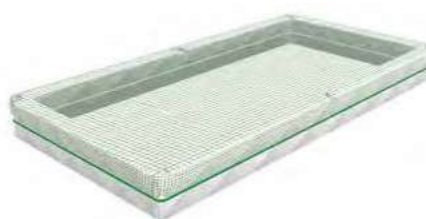

- 220x406

MRE0012SOIFE

Rete antintrusione per sabbiera 2A

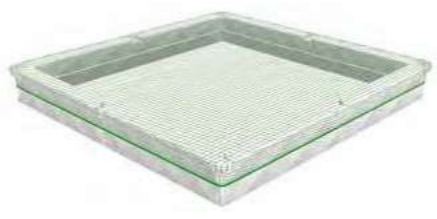

- 306x306

Miraggi 201



- 0,5 - 6
- 638x277x237h

Composto da:
MRC002E
1.160/006
A272008
2.401/002B

Sabbiera 2E
Palo con timone
Bandiera
Casettina B



Miraggi 101

Composto da:
MRC001E
1.160/006
A272008

Sabbiera 1E
Palo con timone
Bandiera

- 0,5 - 6
- 467x206x205h



Miraggi 401

Composto da:
MRC003D
2.401/002A

Sabbiera 3D
Casettina A

- 0,5 - 6
- 571x571x237h



2.301/A Sabbiera cm 150x150 con coperchio



meccanismo di chiusura di sicurezza delle sabbie con coperchio



0,5 - 6



595x347 m² 24,10

1,5h

2



2.301/B Sabbiera cm 200x200 con coperchio

0,5 - 6



200x400x40h

1,5h

2

698x487 m² 32,09



2.301/B2 Sabbiera cm 200x400 con coperchio

0,5 - 6



200x800x41h

1,5h

2

4x 40x40x50h

1098x487 m² 51,58



2.304/A1 Tavolo 1 vasca h 40



120x55x40h

(vaschetta) 46x35x14h

2.304/A2 Tavolo 1 vasca h 50



120x55x50h

(vaschetta) 46x35x14h

2.304/B1 Tavolo 2 vasche h 40

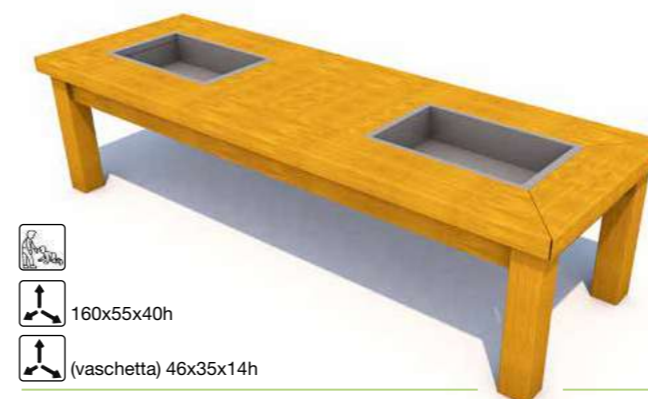

160x55x40h

(vaschetta) 46x35x14h

2.304/B2 Tavolo 2 vasche h 50



160x55x50h

(vaschetta) 46x35x14h

2.304/C1 Tavolo 4 vasche h 40

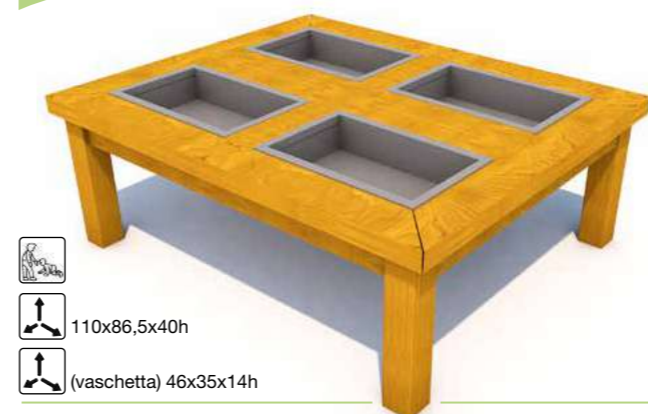

110x86,5x40h

(vaschetta) 46x35x14h

2.304/C2 Tavolo 4 vasche h 50

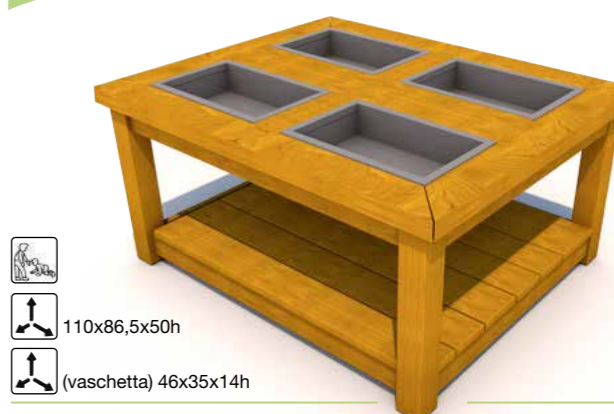

110x86,5x50h

(vaschetta) 46x35x14h

2.771

Orticelli



3+



513x314x64h

807x614 m² 47,60m³ 0,76

1h



2



16x 40x40x60h



designer: Fabio Casadei

2.771/C

Orticelli C



3+



314x314x64h

607x614 m² 35,32m³ 0,576

1h



2



12x 40x40x60h



designer: Fabio Casadei

2.772

Ortolina



2.772

Ortolina



3+



150x60x46h

450x360 m² 13,85

0,2h



2



2.772/A

Ortolina A



3+



150x60x70h

450x360 m² 13,85

0,2h



2



2.778/A

P-Orto A



3+



200x130x44h

500x430 m² 19,42

0,2h



2

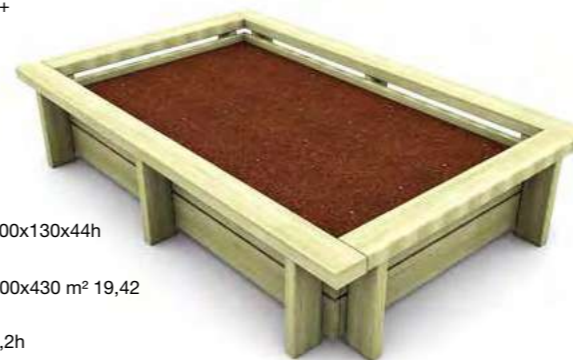

2.778/B

P-Orto B



3+



200x130x44h

500x430 m² 19,42

0,2h



2

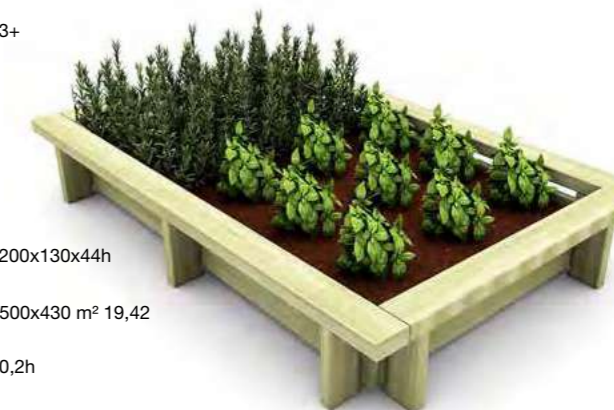

S108215

S108216

S107179

S107180

3.703

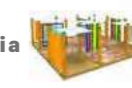

2.779/A

Orti verticali (piccolo)

Da parete

- 3+
-
- 125x22x115h



2.779/B

Orti verticali (medio)

Da parete

- 3+
-
- 124x42x119h



2.779/C

Orti verticali (grande)

- 3+
-
- 125x70x119h



2.780/A

Serra orticola singola

- 3+
-
- 175x45x82h



2.780/B

Serra orticola doppia

- 3+
-
- 175x90x82h



Vedi anche: Fioriera quadrata

p. 257

Fontanella in legno

p. 259

2.825/L

Schizzo

- 1,5+
- 49x49x85h
- m³ 0,04
- 1x 40x40x50h



designer: Fabio Casadei

2.781/A

Compostiera piccola

- 3+
-
- 100x53x73h



2.781/B

Compostiera grande

- 3+
-
- 100x94x73h



2.782/A

Kit accessori 1



VERI ATTREZZI PER GIARDINAGGIO A MISURA DI BAMBINO
Composizione kit: Griffino, Forchetta, Triplantatore, Foraterra, Innaffiatolo

- 6 - 12
- 28h

2.782/B

Kit accessori 2



VERI ATTREZZI PER GIARDINAGGIO A MISURA DI BAMBINO
Composizione kit: Vanghetta, Scopetta ferro, Zappino, Pala quadra, Rastrello, Scopa saggina. Manico in legno di faggio

- 6 - 12
- 88h

2.782/C

Kit accessori 3



VERI ATTREZZI PER GIARDINAGGIO A MISURA DI BAMBINO
Composizione kit: Vanghetto quadro, Badile quadro, Rastrello 10 dt., Scopa fissa, Zappetta grano. Manico in legno di faggio

- 6 - 12
- 120h

2.783

Parete per attrezzature

-
- 170x11,5x110h



2.787

Cassapanca porta attrezzi

-
- 150x48x50h



Vedi anche: Locanda



p. 127

Garagino



p. 128

Scaffalatura



p. 128



**modulo[®]
più**

*le caratteristiche della natura,
per giocare in modo naturale*

**modulo[®]
più**

per bambini fino **14** anni

Modulo Più è la linea in grado di offrire la più vasta gamma di prodotti da utilizzare nelle aree gioco pubbliche esistente sul mercato. Include tutte le attrezzature ludiche classiche come altalene, bilici, cassette gioco, torrette e scivoli; anche un'ampia selezione di attrezzature a livello terra o ad altezze estremamente ridotte come passerelle, pannelli attività, piani e altri articoli che ben si integrano nel paesaggio e possono essere utilizzati per creare stimolanti spazi gioco natura.

Giocare in modo naturale

L'attività ludica svolta in aree gioco che presentino le caratteristiche tipiche del mondo naturale giova moltissimo ai bambini, che si sentiranno più a contatto con la natura e gli altri esseri viventi di quanto non lo siano gli adulti. I ragazzi hanno un'innata tendenza a giocare con gli oggetti per scoprire come sono fatti e come funzionano: è il loro modo di raccogliere informazioni e acquisire conoscenza.

Libertà nella natura

Gli svariati modi in cui i bambini vengono separati dalla vita quotidiana degli adulti, dalla natura e dagli elementi naturali, non li aiutano affatto. Il loro compito, in quanto bambini, è quello di apprendere come vivere al giorno d'oggi in questo ambiente globale e di imparare dagli adulti di oggi. Per svolgere bene questo lavoro, devono avere l'opportunità di giocare, dato che queste cose si imparano solo mediante l'attività ludica. Giocare in spazi dove il livello dei materiali e degli

oggetti naturali è estremamente alto, sarà molto più vantaggioso per loro che non farlo in aree arredate con materiali sintetici come plastica, gomma, metallo e cemento. I bambini trovano la propria libertà e armonia interiore nella natura, che li ispira e nutre la loro curiosità e fantasia.

Modulo Più è una serie di articoli ludici e arredi per aree gioco da utilizzare in un contesto naturale, dove le piante ed il design paesaggistico rivestano un ruolo di primo piano: erba, sabbia, acqua, cespugli, alberi ed altre caratteristiche naturali. Il materiale principale è il legno e ci prendiamo cura del fatto che molte delle parti con le quali i bambini vengono a contatto come ad esempio corrimano, bordi degli scivoli, piani ecc. siano in legno.

Il legno, in quanto elemento naturale, non solo crea un senso di benessere nei bambini, ma si armonizza in modo ideale con l'ambiente naturale circostante.



**Modulo più è scelta:
da un'ampia gamma di
piccole unità ludiche
per incrementare
il gioco attivo**



**Scelta:
da un'ampia gamma di
attrezzature ludiche
per il gioco inclusivo...
tutti i ragazzi potranno
giocare insieme!**



**Scelta:
da una vastissima
selezione di torrette
con varie opportunità
ludiche per accrescere il
potenziale di gioco**

**Speciale sistema
di ancoraggio in acciaio
zincato a caldo fissato
al montante tramite
barre filettate incollate
con resine epossidiche**



**Montanti in legno
lamellare di sez. da
95x95mm incollato a
tre lamelle con adesivo
strutturale di tipo I.
Speciale profilo a
"quadrifoglio"**

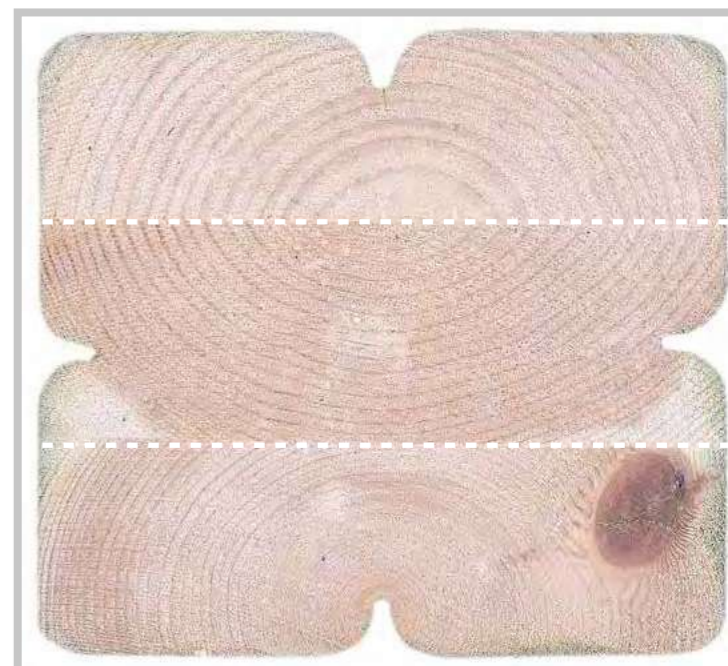

**La lamella superiore
delle sponde degli
scivoli è realizzata
in legno di accoya.
Grazie all'elevata
durezza previene la
formazione di schegge**















modulo[®]
più













1.152/002A Modulo più 152/002A

-  3 - 11
-  m² 59,5
-  776x653x410h
-  m³ 1,39
-  1126x1018 m² 69,02
-  6h
-  192x1018 m² 49,16
-  3
-  248h
-  15x 50x50x85h
6x 25x25x50h 2x 25x25x85h



1.152/003 Modulo più 152/003













-  3 - 9
-  m² 53
-  637x462x410h
-  m³ 1,1
-  988x812 m² 52,75
-  3,5h
-  988x792 m² 45,55
-  3
-  227h
-  11x 50x50x85h
6x 25x25x85h 4x 25x25x50h



1.152/005 Modulo più 152/005



-  3 - 8
-  776x523x410h
-  823x1126 m² 54,89
-  m³ 1,04
-  643x793 m² 34,45
-  150h
-  m² 40
-  3,5h
-  3
-  11x 50x50x85h
2x 25x25x85h 6x 25x25x50h



1.152/007 Modulo Più 152/007

- 3 - 9
- 200h
- m² 54
- m³ 0,981
- 634x526x410h
- 4h
- 984x876 m² 55,41
- 3
- 984x804 m² 46,14
- 10x 50x50x85h
- 4x 25x25x85h
- 5x 25x25x50h



1.152/008A Modulo Più 152/008A

- 5 - 11
- 176h
- m² 56
- m³ 1,137
- 612x551x410h
- 4h
- 912x900 m² 51,46
- 3
- 912x793 m² 45,71
- 12x 50x50x85h
- 4x 25x25x85h
- 2x 25x25x50h



1.152/011 Modulo Più 152/011

- 3 - 9
- 150h
- m² 53
- m³ 1,1
- 815x435x410h
- 3,5h
- 1216x735 m² 59,75
- 3
- 1216x643 m² 48,68
- 11x 50x50x85h
- 5x 25x25x85h
- 4x 25x25x50h



**NUOVO
Predetto**

1.153/001 Modulo più 153/001



- 3 - 11
- 787x575x470h
- 935x1137 m² 76,34
- 912x1029 m² 60,37
- 265h
- m² 70,50
- m³ 1,52
- 6h
- 3
- 16x 50x50x85h
- 6x 25x25x85h
- 1x 25x25x50h



1.153/002A Modulo più 153/002A



- 3 - 11
- 719x694x440h
- 993x1069 m² 71,68
- 865x1069 m² 64,20
- 231h
- m² 74,00
- m³ 1,67
- 7h
- 3
- 18x 50x50x85h
4x 25x25x50h 3x 25x25x50h



1.153/004 Modulo più 153/004



- 3 - 11
- 720x696x410h
- 995x1070 m² 72,51
- 1070x868 m² 63,43
- 237h
- m² 75,5
- m³ 1,6
- 6h
- 3
- 17x 50x50x85h
4x 25x25x50h 7x 25x25x50h

1.153/006 Modulo Più 153/006

NUOVO Prodotto

- 3 - 11
- 785x723x410h
- 1135x1018 m² 82,75
- 1027x923 m² 59,24
- 150h
- m² 64,25
- m³ 1,52
- 6h
- 3
- 16x 50x50x85h
6x 25x25x85h 5x 25x25x50h



1.153/007 Modulo Più 153/007

NUOVO Prodotto

- 3 - 11
- 694x840x410h
- 993x1178 m² 77,25
- 866x1132 m² 65,97
- 150h
- m² 72,25
- m³ 1,1
- 7h
- 3
- 16x 50x50x85h
8x 25x25x85h 5x 25x25x50h



1.158/B001 Modulo più 158/B001

- 5 - 11
- m² 72
- 1349x857x477h m³ 3,58
- 1579x1252 m² 121,16 28h
- 1012x866 m² 54,99 4
- 210h 40x 50x50x85h
4x 25x25x85h 1x 25x25x50h



1.158/D001 Modulo più 158/D001



- 5 - 11
- m² 109,5
- 954x929x477h m³ 2,25
- 1253x1229 m² 103,7 20h
- 1253x1123 m² 89,91 4
- 210h 24x 50x50x85h
6x 25x25x85h 6x 25x25x50h



1.159/A001 Modulo più 159/A001

- 5 - 11
- m² 177
- 1648x1173x772h m³ 50h
- 1938x1486 m² 177 50h
- 228h 5
- 6x 80x52x80h 2x 110x30x70h 1x 80x80x80h
29x 52x52x80h 3x 70x30x70h 3x 70x50x80h



1.159/A002 Modulo più 159/A002



- 5 - 11
- m² 177
- 1648x1173x772h m³ 90h
- 1938x1486 m² 177 50h
- 228h 5
- 18x 80x52x80h 4x 70x30x70h





1.118/A001

Castello di Bibbiena 118/A001

2 - 8



1244x803x367h

1151x1532 m² 120,411067x1252 m² 87,34

150h

m² 98,50m³ 2,63

10h

3

28x 50x50x85h
8x 25x25x85h 5x 25x25x50h

designer: Fabio Casadei

1.118/A002

Castello di Bibbiena 118/A002

2 - 8



908x601x367h

949x1252 m² 90,50948x1253 m² 67,91

150h

m² 77,50m³ 1,42

8h

3

17x 50x50x85h
6x 25x25x85h 5x 25x25x50h

designer: Fabio Casadei

1.118/A003

Castello di Orvieto

2 - 8



900x260x280h

949x1252 m² 90,50948x1253 m² 67,91

150h

150h

m² 77,50m³ 0,96

8h











3

13x 50x50x85h
2x 25x25x50h

1.120/C

Battello



 3 - 11	 m ² 85,50
	 m ³ 2,34
 1212x634x360h	 8h
 983x1512 m ² 87,64	 2
 911x1512 m ² 70,30	 25x 50x50x85h 6x 25x25x85h 6x 25x25x50h
 150h	



designer: Fabio Casadei

1.151/009 Modulo più 151/009 Oplà

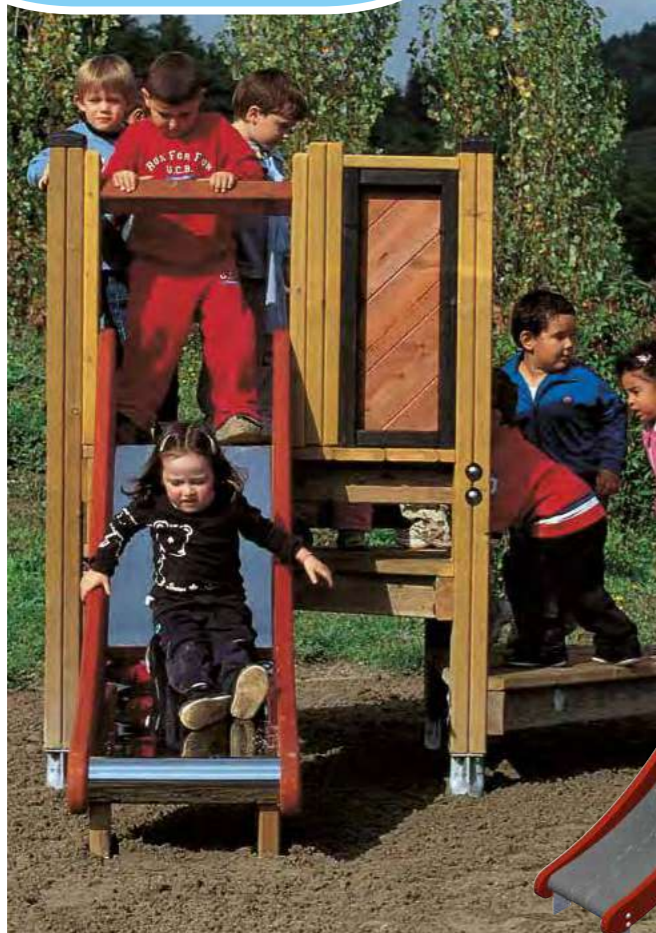

- 1 - 5
- 227x256x174h
- 524x604 m² 23,71
- 417x603 m³ 19,94
- 90h
- m² 25,50
- m³ 0,47
- 1h
- 2
- 5x 50x50x85h
2x 25x25x85h



1.151/011 Modulo più 151/011 Oplà



- 1 - 6
- 231x550x410h
- 900x524 m² 32,74
- 793x524 m³ 28,75
- 150h
- m² 36,50
- m³ 0,65
- 2h
- 2
- 7x 50x50x85h
2x 25x25x85h



1.151/029 Modulo più 151/029



- 1 - 9
- 315x349x350h
- 596x649 m² 31,42
- 541x585 m³ 26,82
- 90h
- m² 31,5
- m³ 1,6
- 5h
- 3
- 11x 50x50x85h
2x 25x25x50h

1.130/A Scivolo da pendio con pedana 90h

- 2+
- 415x603 m² 19,86
- < 60
- 1h
- 117x254x172h
- m² 5
- 2
- 415x603 m² 20,69
- m³ 0,21
- 4x 40x40x60h
2x 25x25x60h



1.130/A1 Scivolo da pendio 90h

- 2+
- 377x496 m² 14,42
- < 60
- 1h
- 78x146x165h
- m² 5
- 2
- 377x496 m² 15,28
- m³ 0,13
- 2x 40x40x60h
2x 25x25x60h



1.131/A1 Scivolo da pendio 150h

- 2+
- 377x578 m² 17,08
- < 60
- 1h
- 78x228x230h
- m² 5
- 2
- 377x578 m² 18,11
- m³ 0,13
- 2x 40x40x60h
2x 25x25x60h



1.132/A Scivolo da pendio con pedana 210h

- 2+
- 495x797 m² 29,62
- < 60
- 1h
- 117x408x292h
- m² 5
- 2
- 495x797 m² 30,65
- m³ 0,23
- 4x 40x40x60h
2x 25x25x60h



1.132/A1 Scivolo da pendio 210h

- 2+
- 457x690 m² 22,99
- < 60
- 1h
- 78x301x290h
- m² 5
- 2
- 457x690 m² 24,03
- m³ 0,13
- 2x 40x40x60h
2x 25x25x60h



1.131/A

Scivolo da pendio con pedana 150h

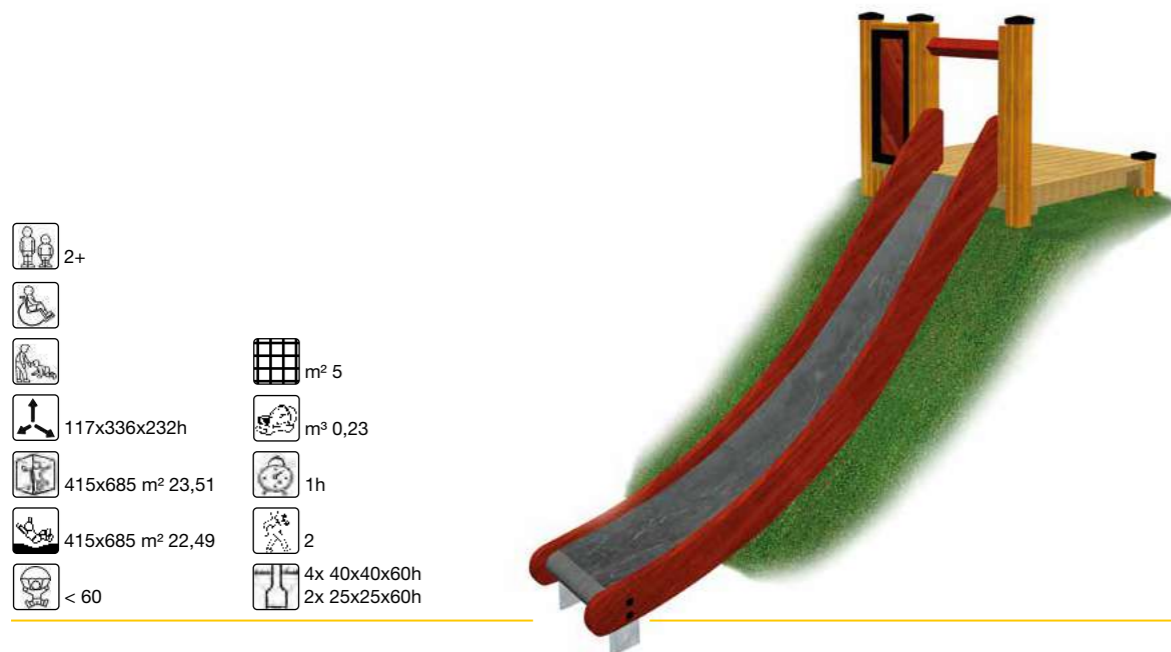

	2+		m ² 5
			m ³ 0,23
			1h
	117x336x232h		2
	415x685 m ² 23,51		4x 40x40x60h
	415x685 m ² 22,49		2x 25x25x60h
	< 60		

1.135/A

Pedana di risalita A

	3 - 11		m ² 7,50
			m ³ 0,24
	117x208x172h		1h
	415x489 m ² 17,88		2
	415x432 m ² 15,78		4x 40x40x60h
	90h		2x 25x25x60h 1x 25x25x50h



1.135/B

Pedana di risalita B

	3 - 11		m ² 12,50
			m ³ 0,24
	117x268x233h		1h
	415x554 m ² 20,42		2
	415x508 m ² 18,62		4x 40x40x60h
	150h		2x 25x25x60h 1x 25x25x50h



1.135/C

Pedana di risalita C

	3 - 11		m ² 15
			m ³ 0,24
	117x318x292h		1h
	495x643 m ² 26,83		2
	495x586 m ² 24,49		4x 40x40x60h
	210h		2x 25x25x60h 1x 25x25x50h



1.151/012

Modulo Più 151/012

1,5 - 5
201x254x350h
603x500 m ² 23,30
603x436 m ² 20,24
90h
m ² 25
m ³ 0,56
1,5h
2
6x 50x50x85h 2x 25x25x85h



1.151/013

Modulo Più 151/013

1,5 - 5	90h	
201x254x174h	m ² 24,5	
603x500 m ² 23,30	m ³ 0,56	2
603x436 m ² 24,97	1h	6x 50x50x85h 2x 25x25x85h



1.151/014

Modulo Più 151/014

1,5 - 5	90h	
118x338x350h	m ² 24,5	
688x415 m ² 23,32	m ³ 0,56	2
623x415 m ² 20,24	1,5h	6x 50x50x85h 2x 25x25x85h



1.151/015

Modulo Più 151/015

1,5 - 5	90h	
118x338x174h	m ² 24,5	
688x415 m ² 23,28	m ³ 0,56	2
415x623 m ² 20,24	1h	6x 50x50x85h 2x 25x25x85h



1.151/016

Modulo Più 151/016

2 - 8	150h	
263x336x410h	m ² 29,5	
685x562 m ² 28,34	m ³ 0,56	2
685x497 m ² 24,97	1,5h	6x 50x50x85h 2x 25x25x85h



1.151/017

Modulo Più 151/017

2 - 8	150h	
263x336x234h	m ² 30,5	
685x562 m ² 28,34	m ³ 0,56	2
685x497 m ² 24,97	2h	6x 50x50x85h 2x 25x25x85h



1.151/018

Modulo Più 151/018

2 - 8	150h	
263x336x410h	m ² 30	
685x562 m ² 28,44	m ³ 0,56	2
685x497 m ² 24,97	2h	6x 50x50x85h 2x 25x25x85h



1.151/026

Modulo Più 151/026

5 - 11
527x392x410h
876x691 m ² 40,75
804x672 m ² 35,41
180h
m ² 43,50
m ³ 0,77
4h
3
8x 50x50x85h 2x 25x25x85h 5x 25x25x50h



designer: Fabio Casadei

1.209/C

Telefunica 30

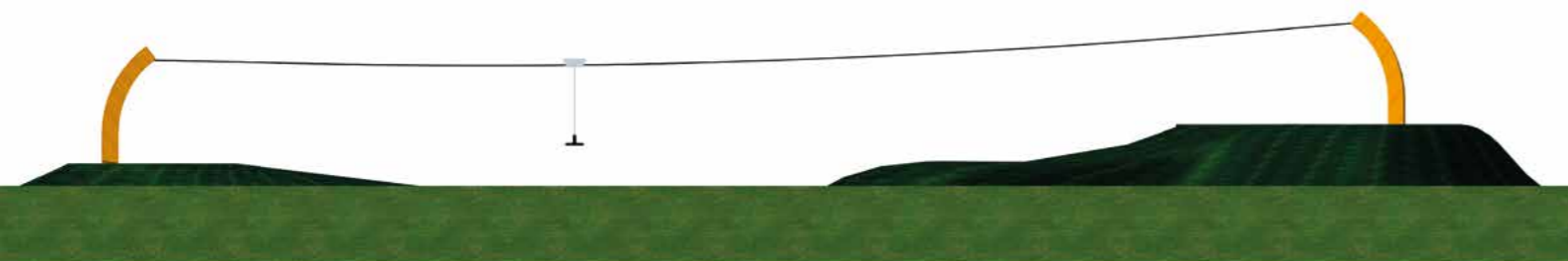
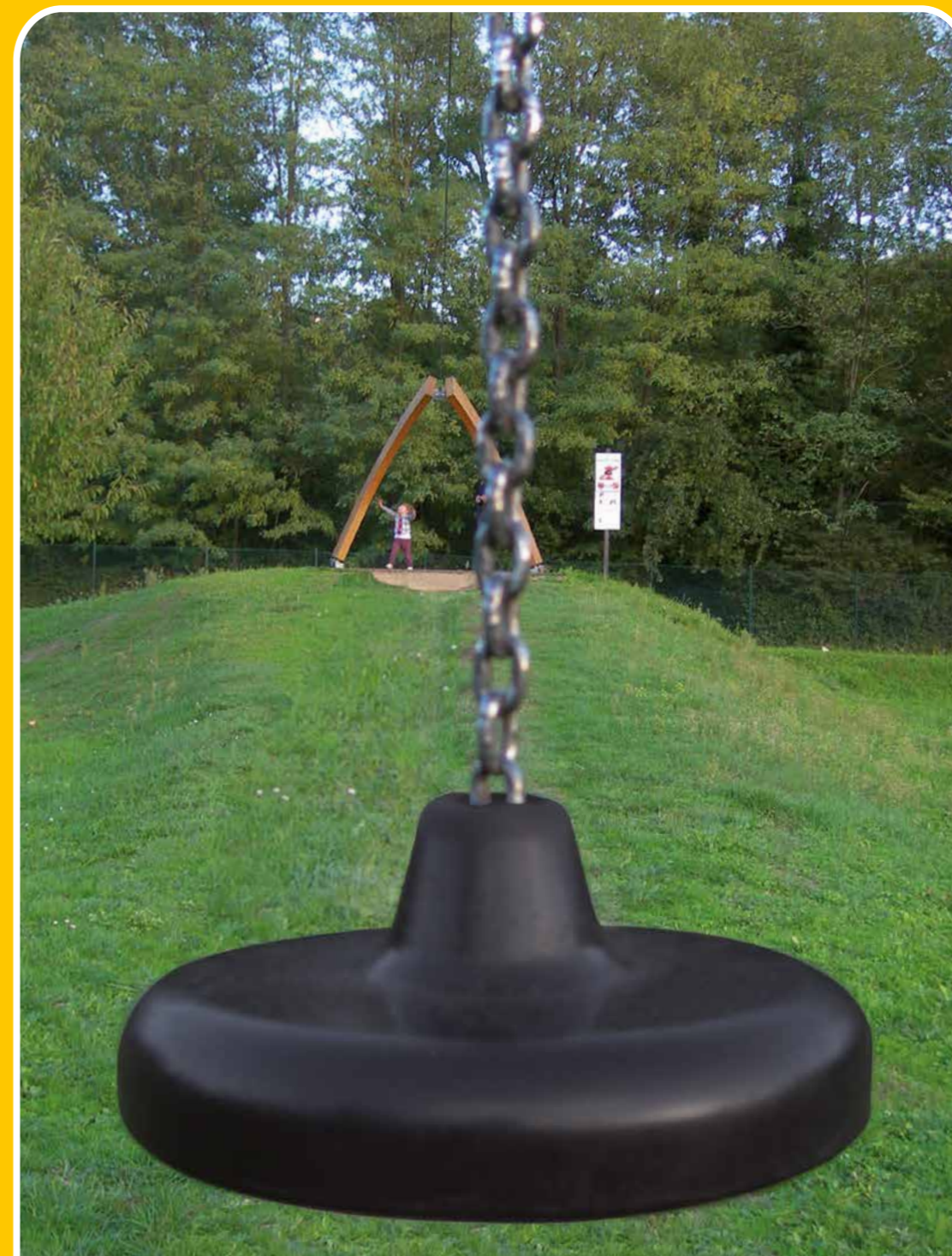
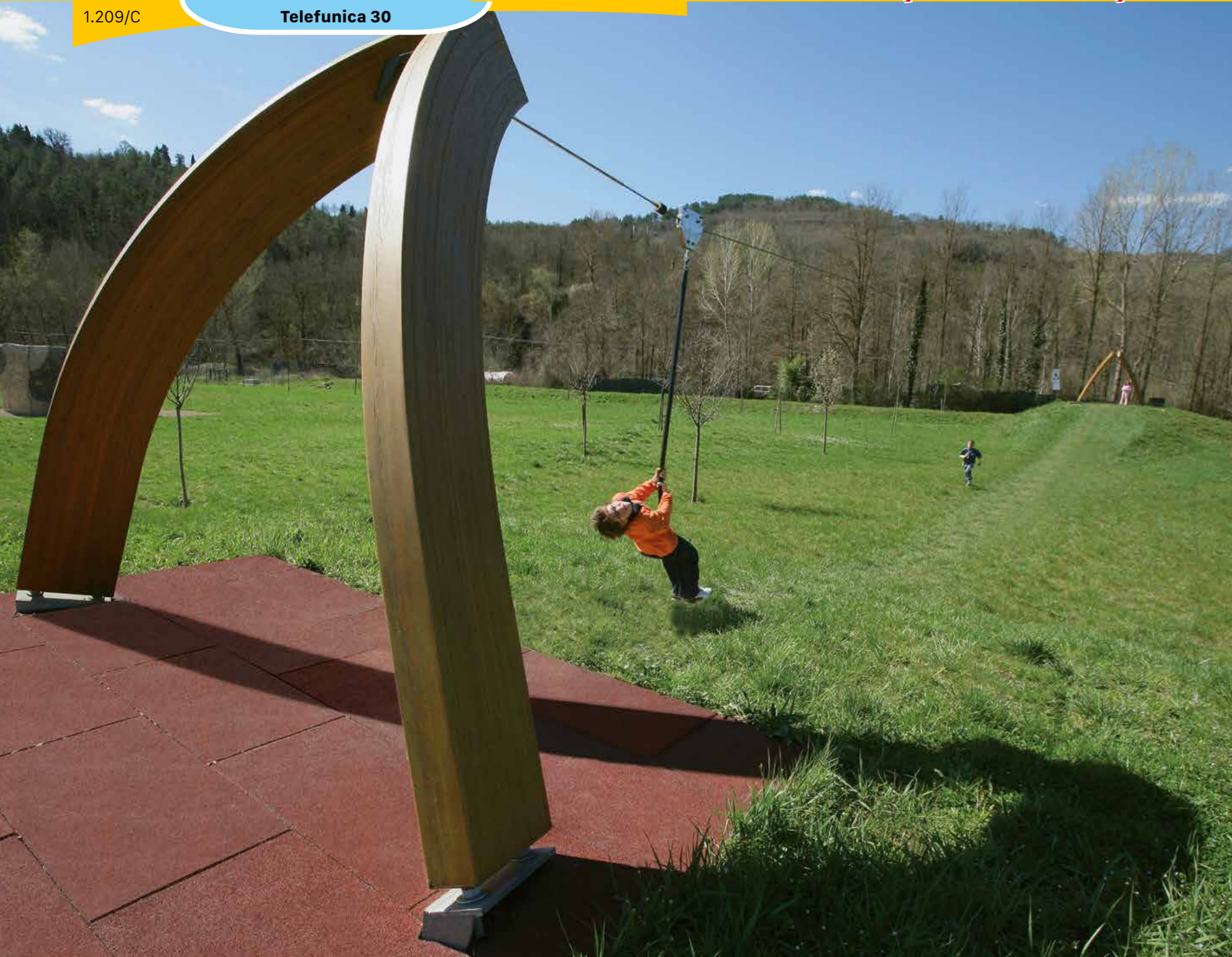

1.209/D

Telefunica 50

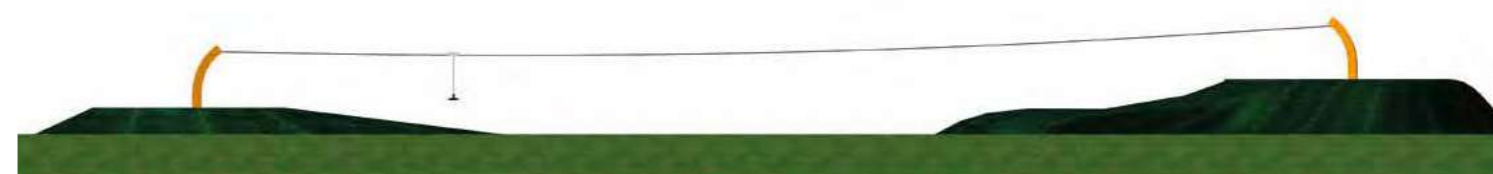

- 6+
- 3410x400 m² 130
- m³ 14
- 3
- 3240x340x310h
- <60h
- 3h
- 2x 400x250x70h

- 6+
- 5410x400 m² 210
- m³ 14
- 3
- 5240x340x310h
- <60h
- 3h
- 2x 400x250x70h

Icaro è una teleferica, adatta ad ambientazioni ed aree gioco soggette a limitazioni di spazio. Massicci travi in lamellare su plinti in acciaio ne assicurano la stabilità. Per facilitare il movimento, sarà necessario scegliere torrette di due altezze diverse nel caso in cui il terreno sia piano e realizzare una collinetta alta 100cm sotto la torretta più alta.









Laddove invece il terreno è collinare (con dislivello compreso tra 90 e 100 cm) si possono scegliere due torrette basse senza la necessità di allestire la collinetta.

Questa struttura, attentamente ingegnerizzata per permettere all'utilizzatore di fermarsi agevolmente, è dotata di parti mobili sigillate per evitare qualsiasi possibile manomissione non autorizzata.



1.208/A

Icaro 30



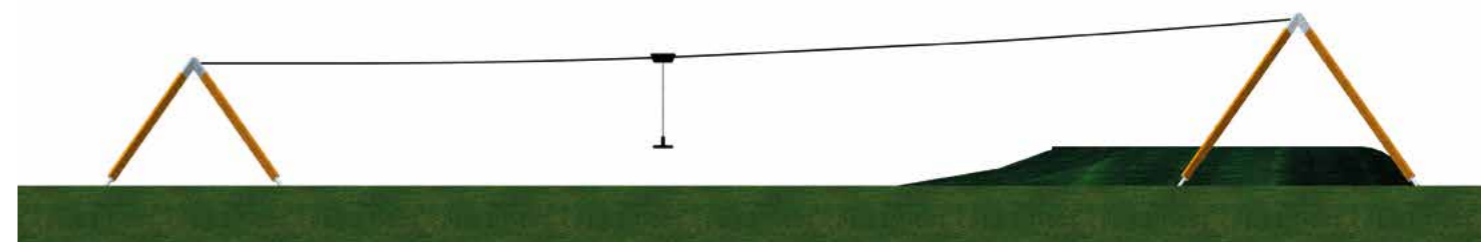





-  3 - 12
-  3562x658x432h
-  3741x838 m² 166,80
-  3741x838 m² 116,80
-  <60h
-  m³ 3,88
-  6h
-  3
-  8x 90x90x100h



designer: Fabio Casadei

1.208/B

Icaro 30

-  3 - 12
-  3470x496x332h
-  3670x696 m² 184,10
-  3670x696 m² 117,40
-  <60h
-  m³ 3,88
-  6h
-  3
-  8x 90x90x100h

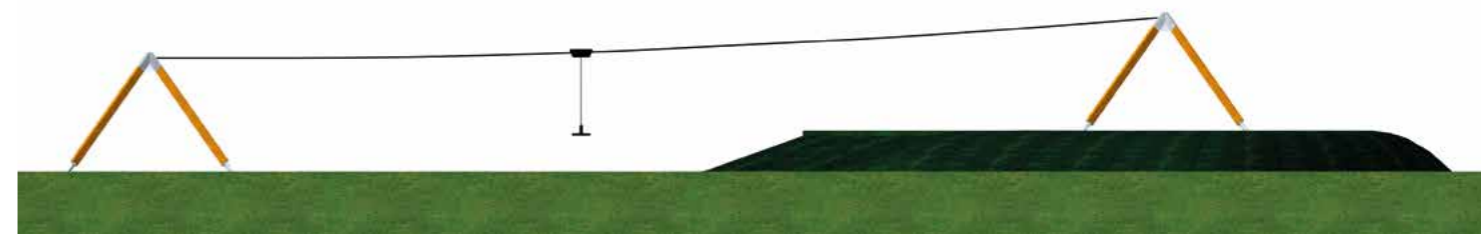

designer: Fabio Casadei

1.330/A

Gallo

- 4 - 8
- 90x30x95h
- 370x310 m² 9,8
- 370x310 m² 9,8
- <60h
- m² 13
- m³ 0,24
- 1h
- 1
- 1x 70x70x50h



designer: Fabio Casadei

1.331/A

Bambi

- 4 - 8
- 88x30x87h
- 310x368 m² 9,73
- 310x368 m² 9,73
- <60h
- m² 13
- m³ 0,24
- 1h
- 1
- 1x 70x70x50h



designer: Fabio Casadei

1.332/A

Leprotto

- 4 - 8
- 87x30x90h
- 310x367 m² 9,69
- 310x367 m² 9,69
- <60h
- m² 13
- m³ 0,24
- 1h
- 1
- 1x 70x70x50h



designer: Fabio Casadei

MPZH1001

Frullo



designer: Fabio Casadei

- 3 - 10
- 470x470 m² 17,34
- m² 25
- Ø 470 m² 17,34
- m³ 0,125
- 1
- Ø70x101h
- <60h
- 0,5h
- 1x 50x50x79h

MPZH1001BIBM

Frullo X



designer: Fabio Casadei

- 3 - 10
- Ø478 m² 17,35
- m² 25
- Ø478 m² 17,35
- m³ 0,125
- 1
- Ø77x97h
- <60h
- 0,5h
- 1x 50x50x79h

1.150/001J

Jim 1

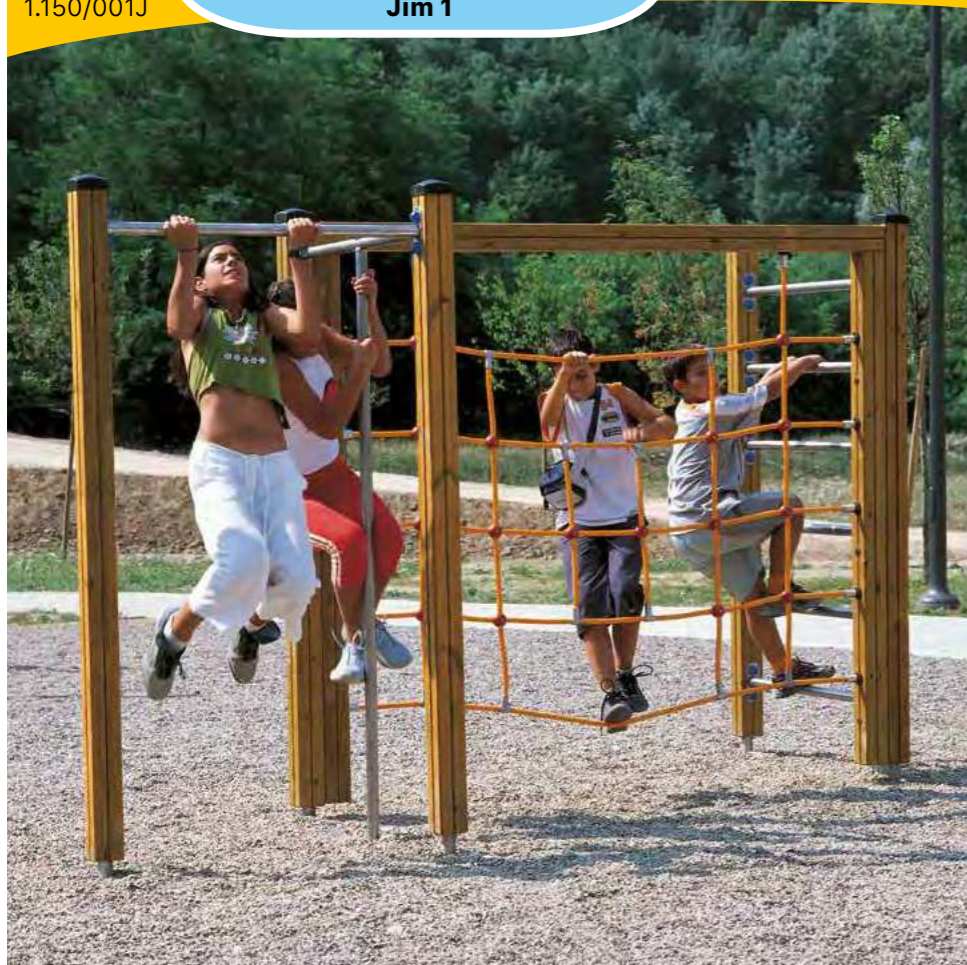

- 6 - 9
- 225x342x208h
- 571x700 m² 28,41
- 571x700 m² 28,41
- 200h
- m² 37
- m³ 0,44
- 1h
- 2
- 5x 50x50x85h
1x 25x25x50h

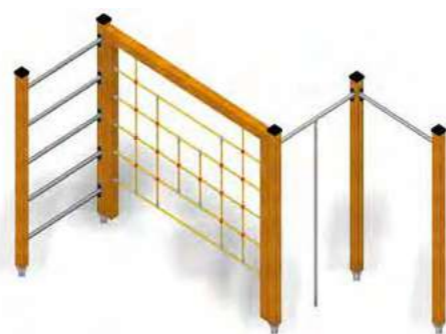

1.150/003J

Jimmi 3



- 3 - 6
- 200h
- m² 60
- m³ 1,33
- 2h
- 2
- 15x 50x50x85h
3x 25x25x50h

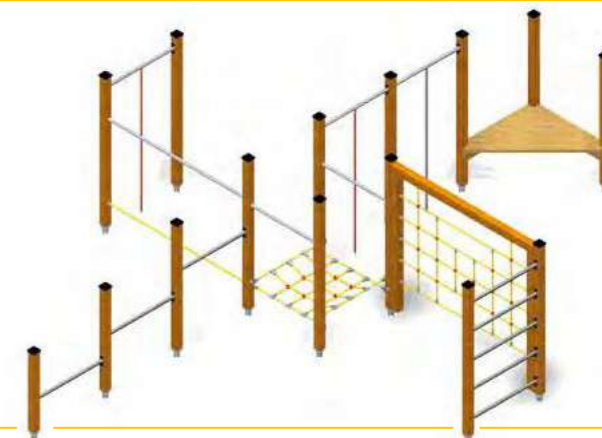

1.150/002J

Jim 2



- 6 - 9
- 342x546x208h
- 695x867 m² 41,5
- 695x867 m² 41,5
- 200h
- m² 48
- m³ 0,8
- 1,5h
- 2
- 9x 50x50x85h
2x 25x25x50h



1.150/004J

Jimmi 4



- 3 - 6
- 191h
- m² 41,5
- m³ 0,94
- 2h
- 2
- 10x 50x50x85h
2x 25x25x580h 5x 25x25x50h

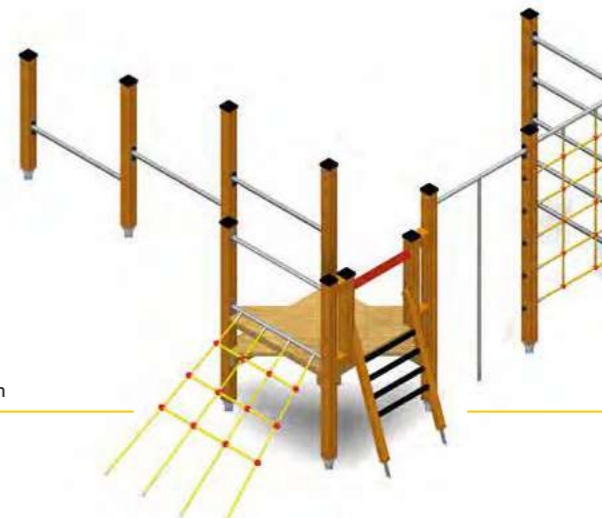

1.150/005J

Jimmi 5



- 3 - 6
-
- 117x225x208h
- 469x577 m² 24,17
- 469x577 m² 24,17
- 191h
- m² 27,5
- m³ 0,45
- 1h
- 2
- 5x 50x50x85h
3x 25x25x50h

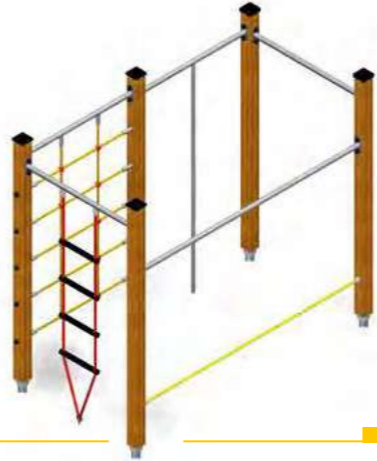

1.150/006J

Wave



- 3 - 11
-
- 452x117x146h
- 752x417 m² 29,40
- < 60
- m³ 0,7
- 1,5h
- 2
- 8x 50x50x85h



1.160/009J

Mini net



- 1 - 11
-
- 117x117x102h
- 417x417 m² 15,49
- <60h
- m³ 0,35
- 0,5h
- 2
- 4x 50x50x85h

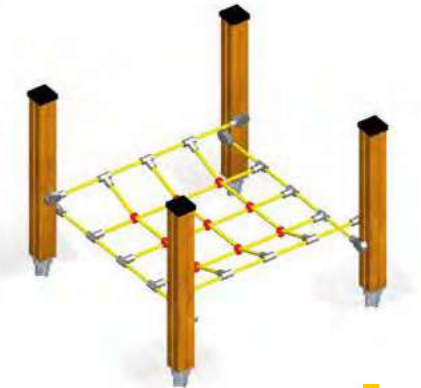

1.730/AJ

Voltolina

- 1,5 - 6
-
- 630x308 m² 17,48
- 122h
- 0,5h
- 330x10x144h
- m² 21,50
- 1
- 630x308 m² 17,48
- m³ 0,35
- 4x 50x50x85h

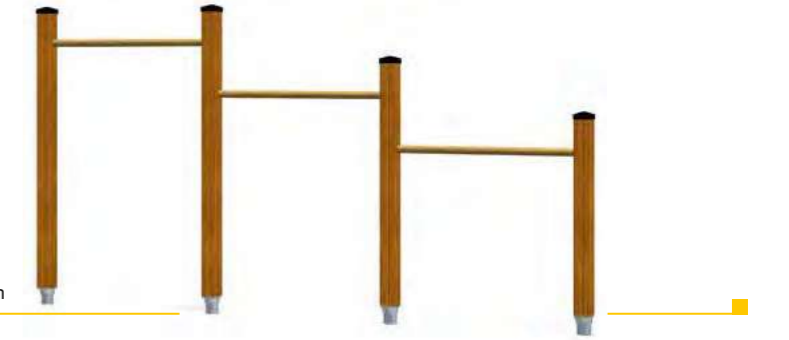

2.703

Snake



- 1,5+
-
- 664x175x39h
- 906x662 m² 30,33
- <60h
- m³ 0,52
- 6x 50x50x85h



2.401/002G

Casettina G

- 2 - 8
- <60h
- m² 0,43
- 1,5h
- 228x123x225h
- 2
- 524x415 m² 18,17
- 5x 50x50x85h



2.401/002E

Bottega

- 2 - 8
- <60h
- m² 0,52
- 1,5h
- 235x228x219h
- 2
- 523x523 m² 20,99
- 6x 50x50x85h



2.409

Play Gazebo

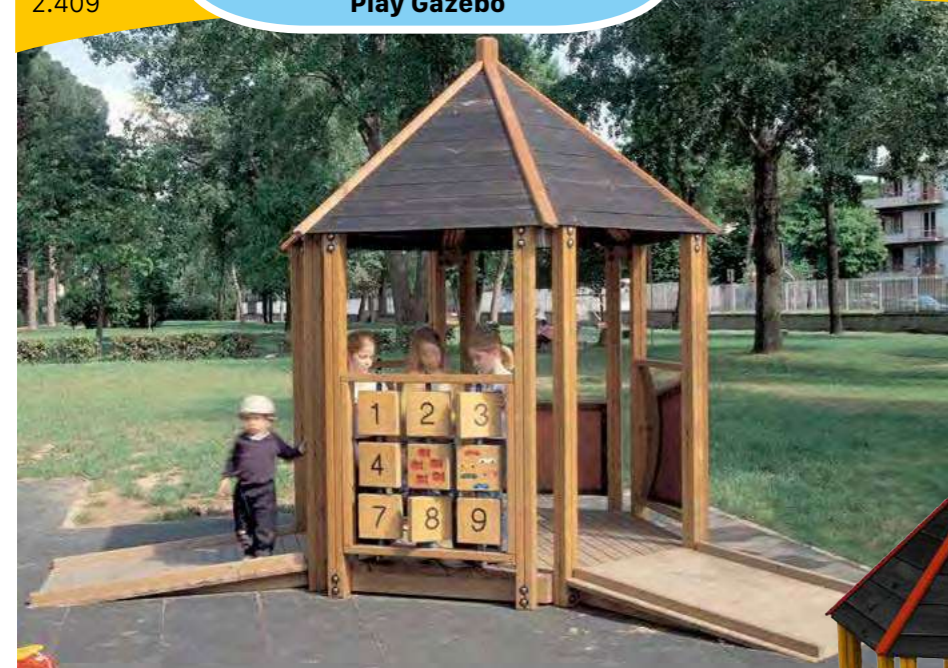

- 1 - 12
- <60h
- m² 0,57
- 2,5h
- 513x305x357h
- 2
- 813x601 m² 35,53
- 12x 40x40x60h



Villa Mirtillo



- Composto da:
- MRC002A **Sabbiera 2A**
 - 2.401/002B **Casettina B**
 - 1.160/001 **Triangolo**
 - 1.151/015 **Modulo Più 151/015 (90cm)**
 - 1.766 **Toccattè**

- 1 - 5
- Accessible play

2.711

Locomotive

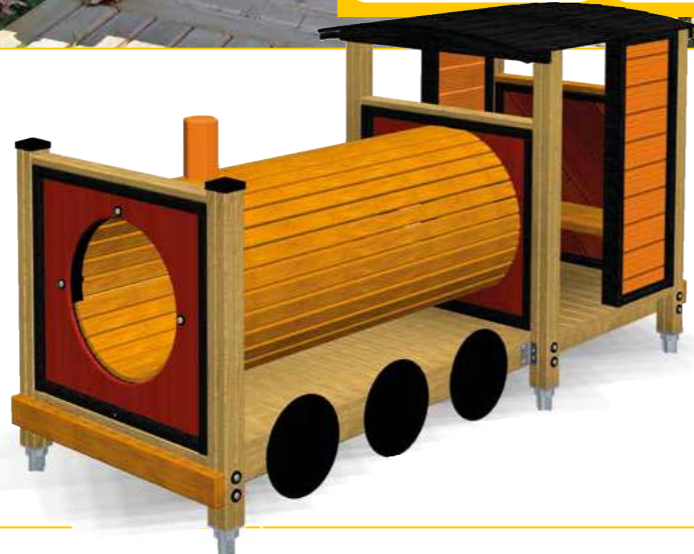

- 1 - 8
- m³ 0,52
- 320x119x172h 0,5h
- 416x615 m² 23,65 4
- <60h 6x 50x50x85h

2.711/B

Coach

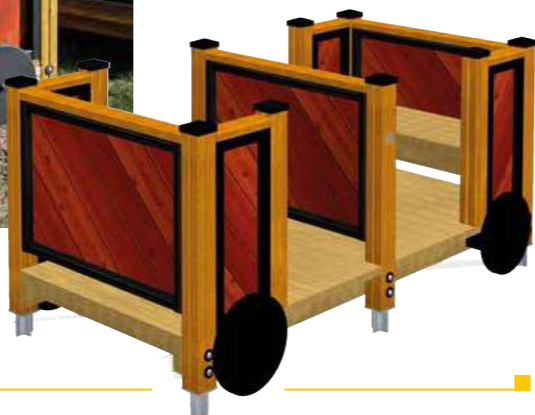

- 1 - 8
- m² 23,50
- 225x123x111h 0,5h
- 417x524 m² 19,90 3
- 417x524 m² 19,90 6x 50x50x85h
- 106h
- m³ 0,52

2.701/A

Rigatoni



- 1 - 10
- 80x194x79h
- 494x379 m² 16,76
- <60h
- m³ 0,096
- 0,5h
- 1
- 2x 40x40x60h

GIOCO DI MANIPOLAZIONE E SENSORIALE

1.160/002

Banchino

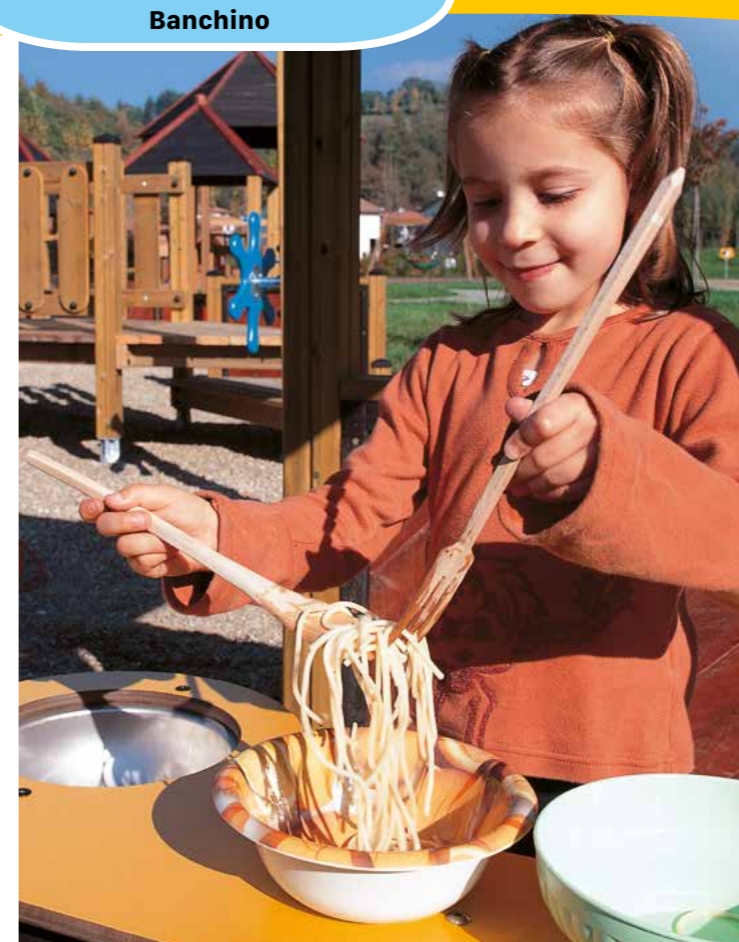

- 1 - 11
- 117x144x84h
- 417x417 m² 13,90
- <60h
- m³ 0,26
- 0,5h
- 2
- 3x 50x50x85h

1.160/003

Banchino + specchio



- 1 - 11
- wheelchair
- person
- 117x144x122h
- 417x417 m² 13,90
- <60h
- m³ 0,26
- 0,5h
- 2
- 3x 50x50x85h

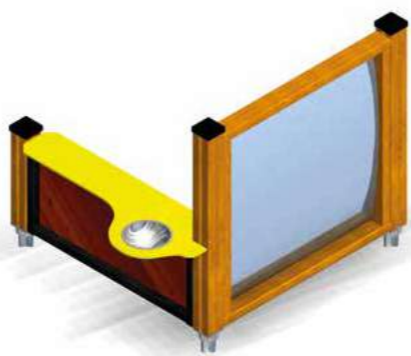

1.160/005B

Pannello con bussola Oplà



- 1 - 11
- wheelchair
- person
- 117x30x91h
- 471x309 m² 10,94
- <60h
- m³ 0,17
- 0,5h
- 1
- 2x 50x50x85h



1.160/006

Palo con timone

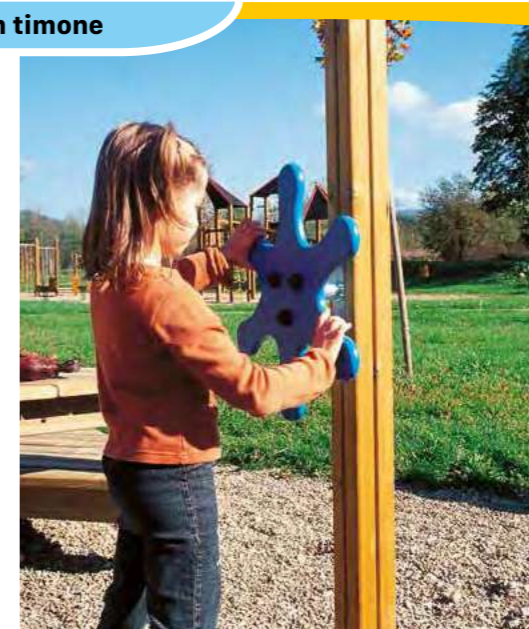

- 1 - 11
- wheelchair
- person
- 50x22x205h
- 309x309 m² 7,62
- <60h
- m³ 0,08
- 0,5h
- 1
- 1x 50x50x85h

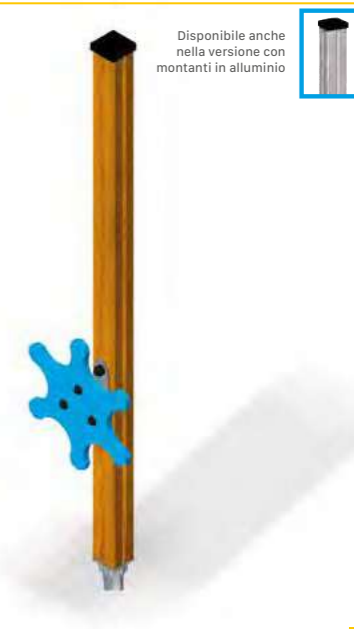

Disponibile anche nella versione con montanti in alluminio

1.160/005A

Pannello + timone



- 1 - 11
- wheelchair
- person
- 117x21x97h
- 417x309 m² 10,94
- <60h
- m³ 0,17
- 0,5h
- 1
- 2x 50x50x85h



1.760

Pannello attività "filetto"



- 2 - 5
- wheelchair
- person
- 117x20x122h
- 416x309 m² 10,93
- <60h
- m³ 0,15
- 0,5h
- 1
- 2x 50x50x60h

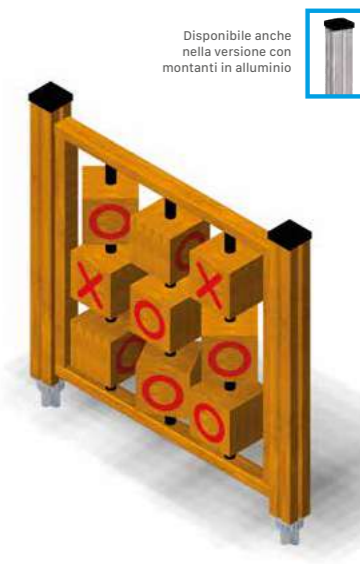

Disponibile anche nella versione con montanti in alluminio

designer: Fabio Casadei

1.761 **Pannello Gioco dei Numeri**

- 2 - 5
-
-
-
- 117x24x122h
- 416x309 m² 10,93
- <60h
- m³ 0,15
- 0,5h
- 1
- 2x 50x50x60h

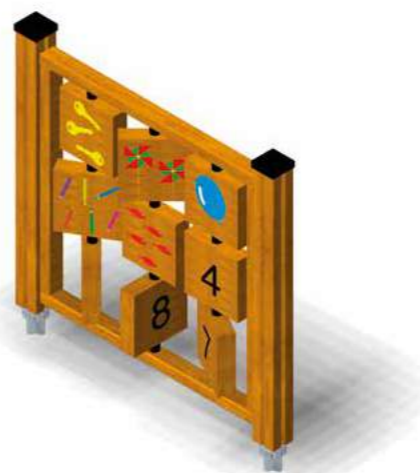

designer: Fabio Casadei

1.764 **Melody**

- 1,5 - 8
-
-
-
- 117x10x122h
- 416x309 m² 10,93
- <60h
- m³ 0,15
- 0,5h
- 1
- 2x 50x50x60h

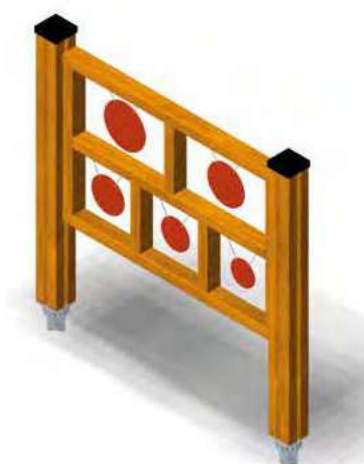

designer: Fabio Casadei

1.762 **Ding-a-ling**

- 2 - 5
-
-
-
- 117x10x122h
- 416x309 m² 10,93
- <60h
- m³ 0,15
- 0,5h
- 1
- 2x 50x50x60h



Disponibile anche nella versione con montanti in alluminio



1.765 **Mira**

- 1,5 - 8
-
-
-
- 117x10x122h
- 416x309 m² 10,93
- <60h
- m³ 0,15
- 0,5h
- 1
- 2x 50x50x60h

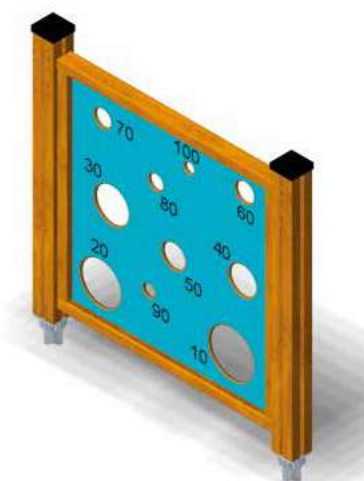

1.763 **Pannello specchio**

- 2 - 5
-
-
-
- 117x10x122h
- 416x309 m² 10,93
- <60h
- m³ 0,15
- 0,5h
- 1
- 2x 50x50x60h



Disponibile anche nella versione con montanti in alluminio



1.766 **Toccattè**

- 1,5 - 8
-
-
-
- 117x10x122h
- 416x309 m² 10,93
- <60h
- m³ 0,15
- 0,5h
- 1
- 2x 50x50x60h

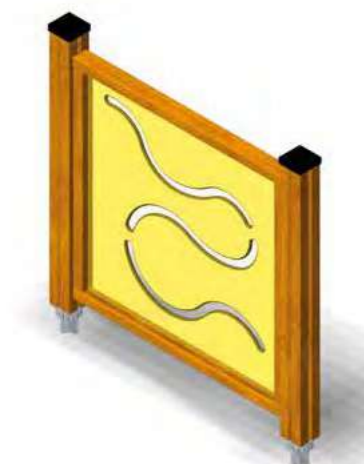



2.303/A

Lilly house A

- 1,5 - 8
- 2
- 3h
- 2
- 12x 30x30x40h



2.303/AP

Lilly house AP

- 1,5 - 8
- 2
- 3h
- 2
- 12x 30x30x40h
1x 80x100x80h

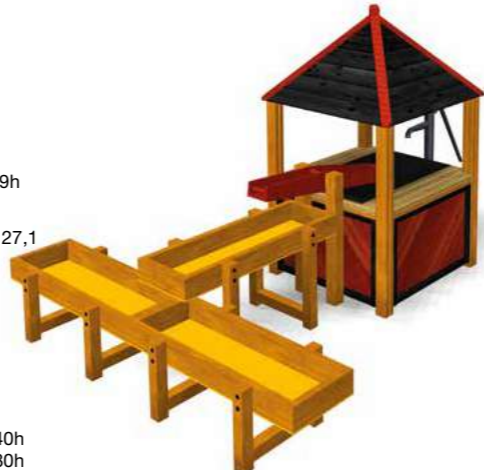

2.303/B

Lilly house B

- 1,5 - 8
- 2
- 3h
- 2
- 8x 30x30x40h



2.303/BP

Lilly house BP

- 1,5 - 8
- 2
- 3h
- 2
- 8x 30x30x40h
1x 80x100x80h



2.305/A

Lilly A

uno scarico

- 1 - 8
- 2
- 3h
- 136x60x70h
- 434x346 m² 13,08
- m³ 0,10
- 4x 30x30x40h



2.305/B

Lilly B

due scarichi

- 1 - 8
- 2
- 3h
- 136x60x46h
- 434x346 m² 13,08
- m³ 0,10
- 4x 30x30x40h



2.305/C

Lilly C

due scarichi

- 1 - 8
- 2
- 3h
- 136x60x70h
- 434x346 m² 13,08
- m³ 0,10
- 4x 30x30x40h



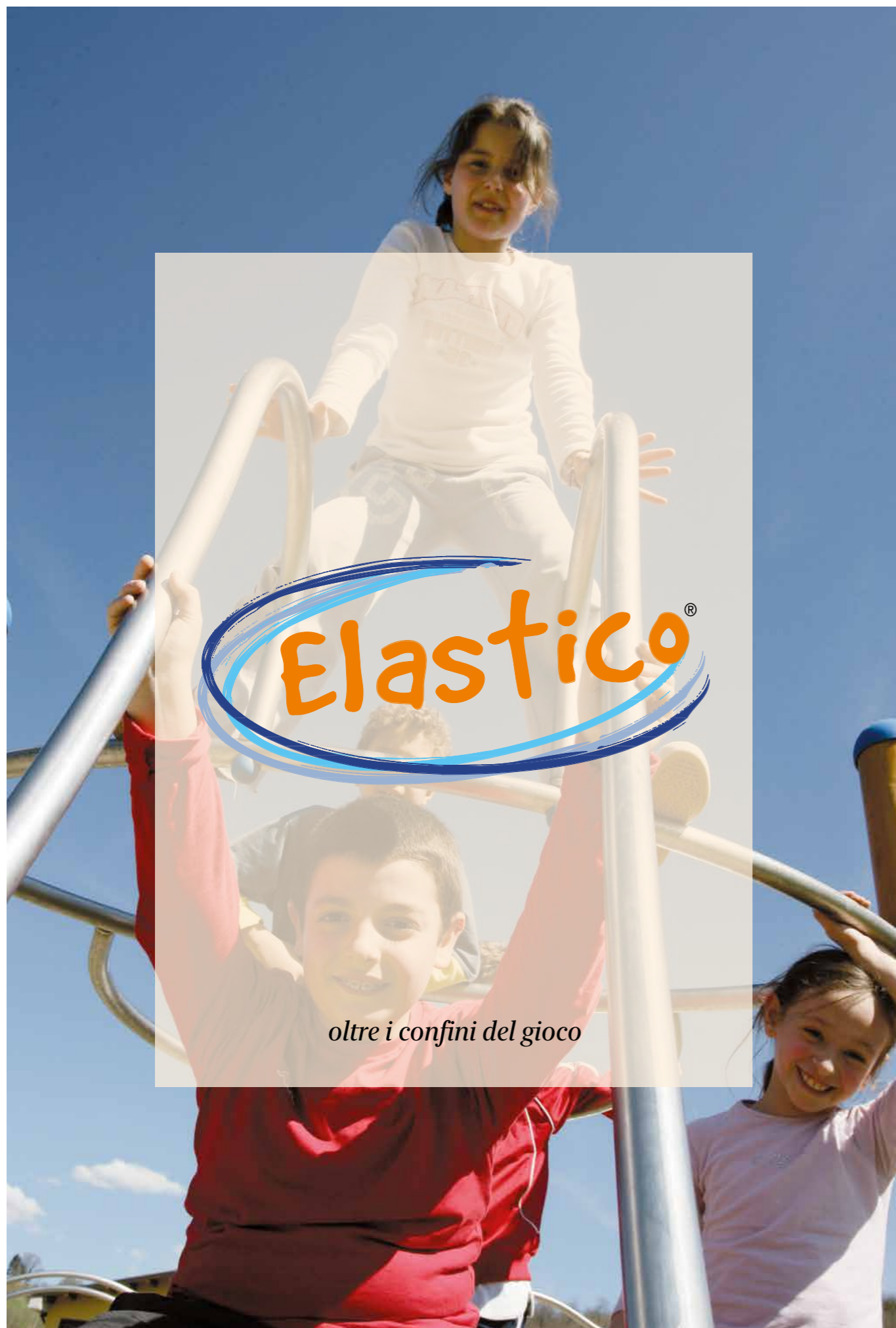

Elastico[®]

oltre i confini del gioco

Elastico[®]

per bambini dai 6 anni

I bambini non amano che qualcuno, in particolare un adulto, tenti di impartire loro lezioni su come giocare. **Elastico** è stato progettato per non forzarli a utilizzare le strutture in un modo piuttosto che in un altro. I prodotti della serie **Elastico** sono un esempio di design italiano contemporaneo, basato su di una nuova interpretazione delle forme ideate per l'area gioco.

Muoversi in modi del tutto nuovi

Il design italiano ha sviluppato una nuova visione del modo in cui i bambini amano giocare, basandosi su concetti ripresi dalla natura e adottando le più avanzate tecnologie per creare possibilità ludiche innovative.

Elastico è un esempio di design minimalista moderno, atto a definire spazi per il movimento per molteplici attività. Saranno i ragazzi a riempire questi spazi con movimenti vigorosi e gioco d'immaginazione, riuscendo ad estendere al massimo i confini del gioco.

Un'esperienza stimolante e una sfida con la libertà

Osservando ciò che avviene quando i ragazzi si arrampicano sugli alberi, si nota subito l'enorme differenza a livello di esperienza corporea rispetto a un'arrampicata su di una struttura ludica a combinazione o una sartia statica. Quando i bambini giocano sugli alberi, questi si flettono in relazione ai loro movimenti: questa flessibilità richiede una risposta coordinata ed altrettanto elastica da parte di tutto il corpo del bambino.

Questa è stata l'intuizione fondamentale che ha caratterizzato il processo di creazione della serie **Elastico**: realizzare strutture ed elementi ludici in grado di flettersi, così da offrire ai bambini esperienze corporee simili a quella di un'arrampicata su di un albero. I ragazzi da 6 anni in poi possiedono buone abilità corporee ed hanno bisogno di spazio per ampi movimenti: per questo motivo le attrezzature devono fungere da cornice per spazi sufficientemente grandi da permettere ogni tipo di movimento flessibile con il corpo.

La flessibilità è stata ottenuta mediante un'ingegnerizzazione speciale e brevettata dei giunti mobili e flessibili e dei congegni a molla: in questo modo i ragazzi, passando da un elemento ludico all'altro, si confrontano con una serie di reazioni e risposte della struttura, secondo il loro peso e dei movimenti che compiono.



**Pendolo,
un modo stimolante
di dondolarsi, che
offre un'ampia
scelta fra molteplici
posizioni corporee**



**Tuvolo,
assai diverso dai soliti
scivoli, può essere
utilizzato in molti modi,
permette una maggiore
libertà di movimento**



**Progettato come piano
di trasferimento per
permettere ai bambini
su sedia a rotelle
di raggiungere l'area
gioco, può essere
utilizzato in molti modi**

**Speciale sistema di
ancoraggio al suolo in
acciaio zincato a caldo
fissato al montante
tramite barre filettate**



**Montanti in legno
lamellare realizzati
con 4 lamelle esterne
a fibratura radiale per
ridurre i fenomeni di
fessurazione**



**I componenti metallici
sono realizzati in
acciaio inox AISI 304
e alluminio, che hanno
una elevata resistenza
meccanica e fisica**



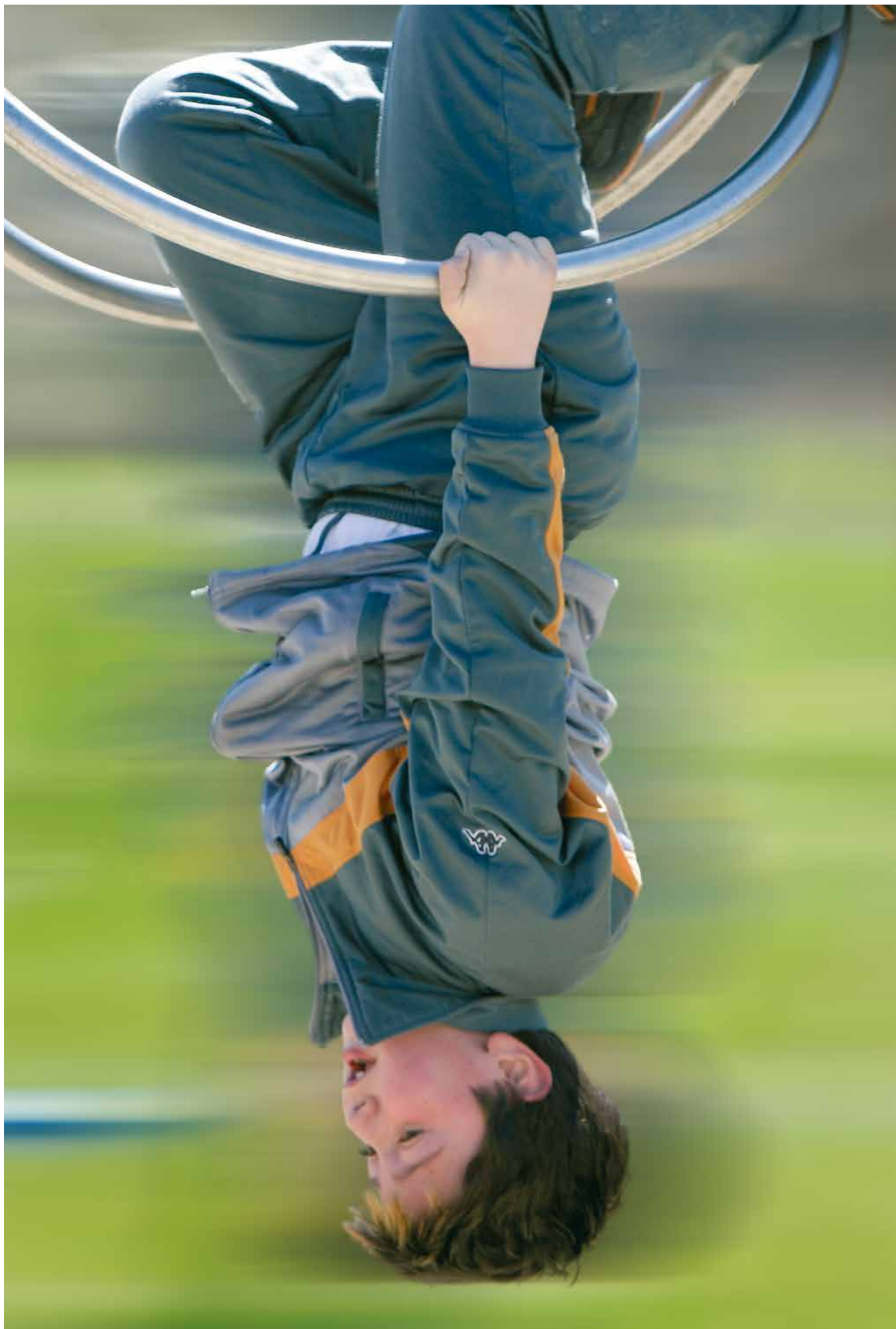

Elastico®



ELC0301

Elastico 301



	6+		m ² 41
	657x327x296h		m ³ 0,543
	627x974 m ² 43,21		6 h
	618x758m ² 32,97		2
	175h		6x 50x50x85h 3x 25x25x75h

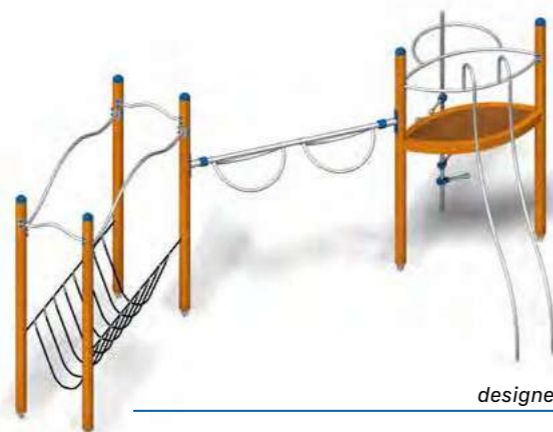

designer: Fabio Casadei

ELC0301SM

Elastico 301 Metal

	6+		m ² 41
	657x327x296h		m ³ 0,543
	627x974 m ² 43,21		6 h
	618x758 m ² 32,97		2
	175h		6x 50x50x85h 3x25x25x75h



designer: Fabio Casadei

ELC0201

Elastico 201

	6+		m ² 48
	513x327x296h		m ³ 0,293
	627x829 m ² 36,89		7 h
	618x830 m ² 36,66		2
	175h		3x 50x50x85h 5x 25x25x75h



designer: Fabio Casadei

ELC0304

Elastico 304

	6+		m ² 60,50
	700x487x296h		m ³ 0,381
	788x1017 m ² 45,67		7 h
	779x1017 m ² 44,66		2
	175h		4x 50x50x85h 5x 25x25x75h



designer: Fabio Casadei

ELC0306

Elastico 306

	6+		m ² 51,50
	622x494x296h		m ³ 0,543
	794x939 m ² 45,99		8 h
	735x891 m ² 41,35		2
	175h		6x 50x50x85h 3x25x25x75h



designer: Fabio Casadei



ELC0402

Elastico 402





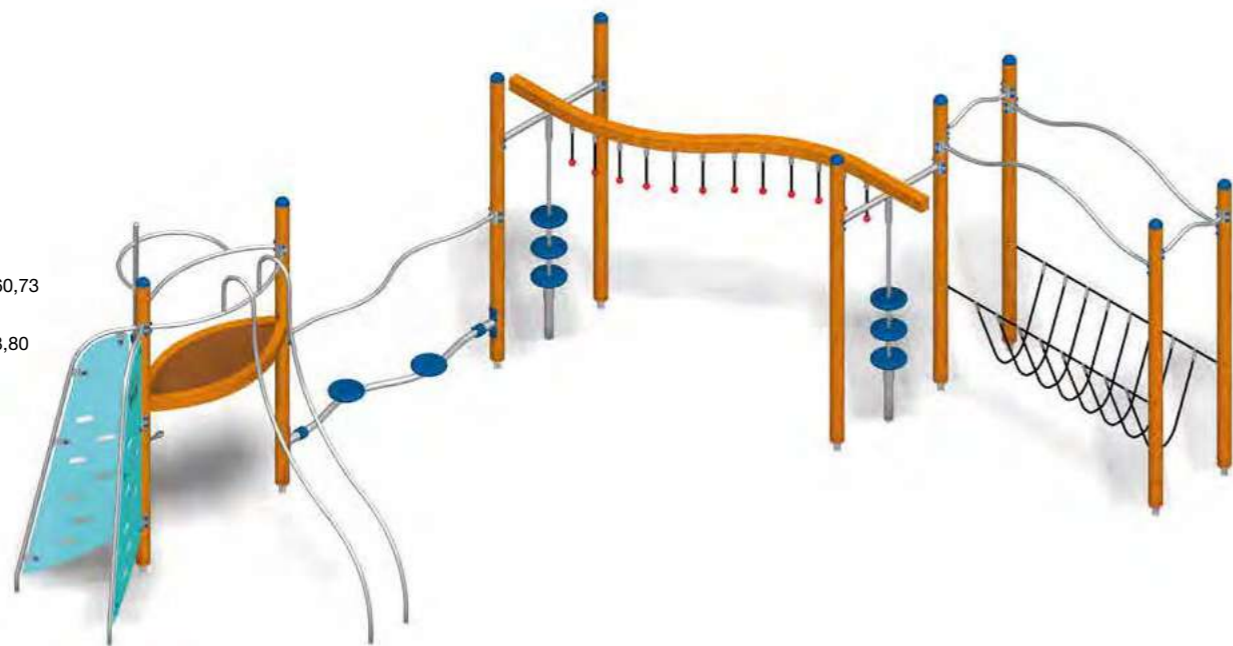







-  6+
-  833x657x296h
-  956x1131 m² 60,73
-  701x987 m² 43,80
-  175h
-  m² 55
-  m³ 0,818
-  8 h
-  2
-  9x 50x50x85h
5x 25x25x75h



designer: Fabio Casadei

ELC0501SM

Elastico 501 Metallo











-  8 - 12
-  657x327x296h
-  627x974 m² 43,21
-  618x758 m² 32,97
-  175h
-  m² 41
-  m³ 0,543
-  6 h
-  2
-  6x 50x50x85h
3x 25x25x75h



ELC0601

Elastico 601



-  6+
-  1155x894x296h
-  1419x1103 m² 82,40
-  908x1100 m² 55,94
-  175h
-  m² 72,50
-  m³ 0,993
-  10 h
-  2
-  11x 50x50x85h
5x 25x25x75h

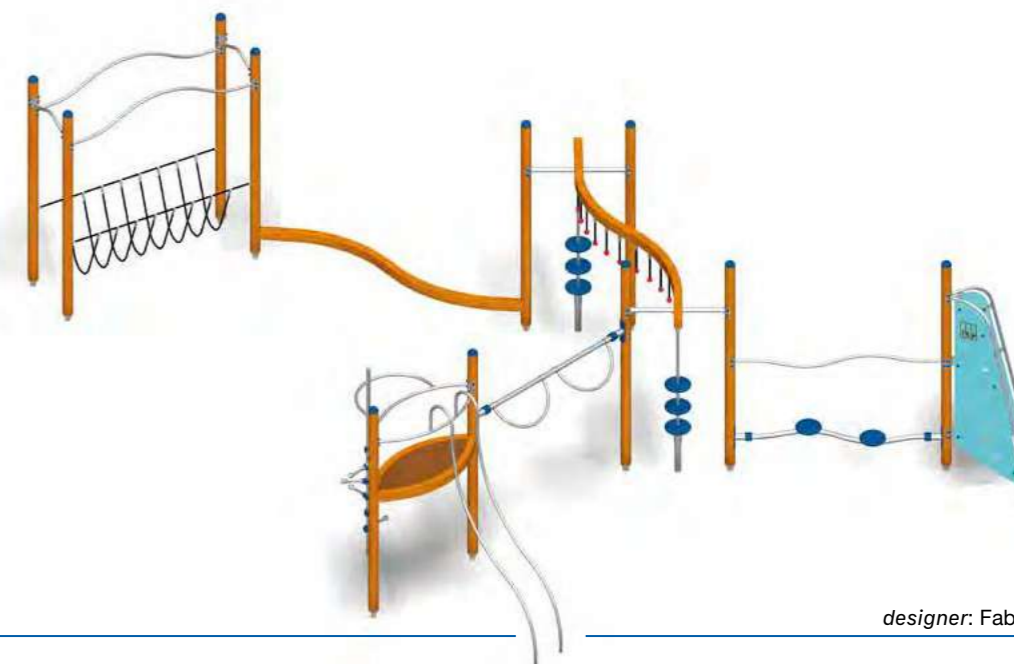

designer: Fabio Casadei

ELE0006

Vedetta



- 6+
- 326x174x296h
- 496x627 m² 21,99
- 496x618 m² 21,73
- 175h
- m² 26,50
- m³ 0,187
- 4 h
- 2
- 2x 50x50x85h
3x 25x25x75h

BILICI, GIOCHI CON MOLLA E GIOCHI DI ROTAZIONE

designer: Fabio Casadei



ELE0019

Elico



- 6+
- Ø110x191h
- Ø710 m²39,59
- Ø510 m²20,43
- 100h
- m² 29,00
- m³ 0,32
- 1 h
- 1
- 1x 80x80x96h



designer: Fabio Casadei

ATTREZZI GINNICI E DI EQUILIBRIO

ELE0017

Trottolo



- 4+
- 330x331 m² 8,41
- <60h
- m³ 0,064
- Ø31x106h
- 1x 40x40x80h

ELE0018

Discolo



- 4+
- 331x331 m² 8,42
- <60h
- m³ 0,125
- Ø31x46h
- 1x 50x50x79h

ELE0001

Sballotto



- 4+
- 262x92x296h
- 558x388 m²19,76
- <60h
- m³ 0,35
- 3 h
- 2
- 4x 50x50x85h



designer: Fabio Casadei

ELE0008

Traballo



- 3+
- <60h
- 300x21x44h
- 600x313 m²16,62
- <60h
- m³ 0,196
- 1 h
- 2
- 403x403 m² 13,97
- 2x 70x70x50h



designer: Fabio Casadei



 **policrosalus**®

star bene all'aria aperta

 **policrosalus**®

i colori della salute

Policrosalus è una serie di stazioni di fitness per spazi aperti con cartelli di guida all'utilizzo, da installare lungo percorsi brevi, medi e lunghi. Queste stazioni sono state progettate includendo elementi di divertimento e fitness, in modo da poter essere utilizzate da persone di ogni età. Ogni stazione corredata d'istruzioni per l'uso è stata sviluppata da un esperto in cinetica umana e movimento.

All'aperto è più vantaggioso

Vivere in città non significa soltanto lavorare e stressarsi, è anche fare moto, socializzare con gli altri e ricrearsi nelle aree verdi.

Gli ultimi risultati della ricerca sull'odierno stile di vita dimostrano che restiamo spesso seduti per troppo tempo, sia in macchina, che in ufficio o a scuola, che in casa: insomma siamo sedentari. I percorsi **Policrosalus** sono una buona opportunità per integrare nel proprio stile di vita il movimento e l'esercizio all'aperto, immersi nella natura, all'aria fresca e alla luce del sole. **Policrosalus** è dunque un modo salutare e divertente di bilanciare lo stress negativo e di mantenersi in forma per affrontare le crescenti pressioni della vita in città.

L'attività motoria regolare aiuta a conservare in salute la struttura ossea e quella muscolare, un fattore molto importante non solo per i bambini, ma per le persone di tutte le età.

Le città sono i forzieri che racchiudono i tesori della civiltà, il cui progresso è contraddistinto dalla qualità e dal tipo d'infrastrutture per il tempo libero messe a disposizione dalla città stessa.

Policrosalus prende atto del fatto che ogni persona è diversa per quanto riguarda i livelli di fitness, forza fisica e abilità.

Ogni stazione è stata progettata per essere utilizzata anche da coloro che non sono molto allenati o hanno problemi di salute che richiedono attenzione durante l'esercizio fisico. Gli utenti ben allenati continueranno a trarre beneficio dalle stazioni utilizzandole regolarmente. La distanza fra le stazioni di esercizio sarà determinata dalla topografia, dalla vegetazione e dallo spazio disponibile. Maggiori distanze permetteranno agli utenti di praticare maggiormente la corsa o la camminata veloce.



Policrosalus è stato progettato dal Prof. Giovanni Notarnicola, esperto in fisiologia e cinetica umana

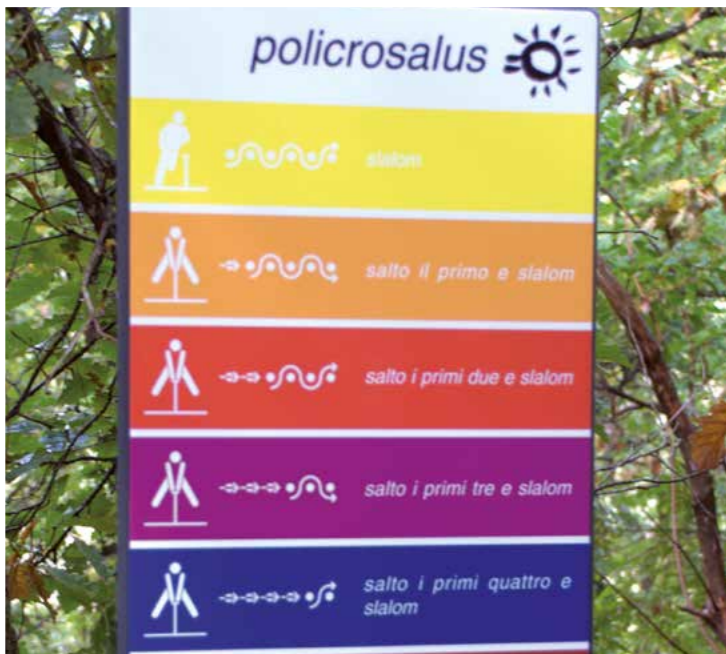

Gli esercizi da eseguire su ogni attrezzo sono illustrati e specificati dal relativo cartello posto nelle vicinanze



Le attrezzature sono realizzate con varie materie prime, al fine di soddisfare le caratteristiche progettuali e i requisiti d'uso

Speciale sistema di ancoraggio in acciaio zincato a caldo fissato al montante tramite barre filettate incollate con resine epossidiche



Barre orizzontali in legno o acciaio inossidabile e piastre di ancoraggio ai montanti in nylon



Tutti gli articoli presentati sono prodotti e certificati secondo la norma UNI EN 16630:2015





PLC0002

Policrosalus 10

PLE0000

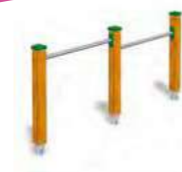

PLE0001



PLE0002

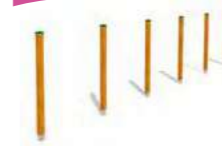

PLE0006



PLE0007



PLE0010



PLE0011



PLE0013



PLE0014



PLE0015



PLC0001

Policrosalus 16

PLE0000

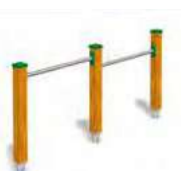

PLE0001



PLE0002



PLE0003



PLE0004



PLE0005



PLE0006



PLE0007



PLE0008



PLE0009

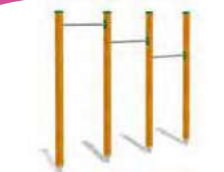

PLE0010



PLE0011



PLE0012



PLE0013



PLE0014



PLE0015



PLC0003

Policrosalus 7

PLE0000



PLE0001



PLE0004



PLE0006



PLE0007



PLE0011



PLE0014



I pannelli esplicativi sono disponibili nelle seguenti lingue: Italiano, Inglese, Spagnolo, Tedesco, Portoghese, Francese, Sloveno

Disponibile anche con sbarre in legno



PLE0000

Riscaldamento



PLE0100

- 225x10x102h
- m³ 0,26
- 0,2h
- 1
- 3x50x50x85h



PLE0200



PLE0003

Stazione per lo stretching



PLE0103

- 434x34x103h
- m³ 0,26
- 0,3h
- 1
- 3x50x50x85h



PLE0001

Tris di attrezzi di equilibrio



PLE0101

- 697x79x30h
- m³ 0,70
- 0,7h
- 1
- 8x50x50x85h



PLE0004

Stazione per salti (6 funghetti)



PLE0104

- 1024x24x99h
- m³ 0,52
- 0,5h
- 1
- 6x50x50x85h



PLE0002

Sei ritzi per slalom



PLE0102

- 1010x10x182h
- m³ 0,70
- 0,3h
- 1
- 6x50x50x85h



PLE0005

Stazione per la coordinazione e il potenziamento dei legamenti



PLE0105

- 225x10x162h
- m³ 0,26
- 0,2h
- 1
- 3x50x50x85h

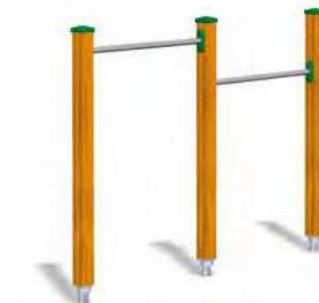

PLE0006

Stazione per la coordinazione muscolare e l'equilibrio



PLE0106

- 257x90x112h
- m³ 0,35
- 0,3h
- 1
- 4x50x50x85h



PLE0009

Stazione per il potenziamento della muscolatura addominale e delle braccia



PLE0109

- 332x10x252h
- m³ 0,35
- 0,25h
- 1
- 4x50x50x85h



PLE0007

Stazione per il potenziamento della muscolatura dorsale



PLE0107

- 225x10x252h
- m³ 0,26
- 0,5h
- 2
- 3x50x50x85h



PLE0010

Stazione per il potenziamento della muscolatura addominale



PLE0110

- 258x423x167h
- m³ 0,70
- 0,4h
- 2
- 8x50x50x85h



PLE0008

Stazione per esercizi con le caviglie e le gambe



PLE0108

- 270x110x212h
- m³ 0,70
- 1h
- 2
- 8x50x50x85h



PLE0011

Stazione per esercizi addominali, per il potenziamento delle cosce e la presa delle mani





PLE0111

- 460x25x295h
- m³ 0,38
- 0,25h
- 2
- 2x72x72x85h
3x25x25x50h



PLE0012

Stazione per esercizi dorsali, con le cosce e per la muscolatura del torace

-  225x125x79h
-  m³ 0,35
-  0,2h
-  1
-  3x50x50x85h
2x40x40x60h

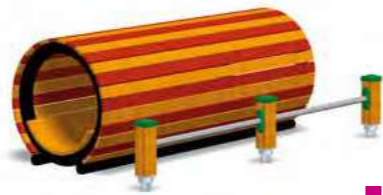

PLE0013

Stazione per la coordinazione acrobatica

-  300x285x137h
-  m³ 0,70
-  0,25h
-  2
-  8x50x50x85h

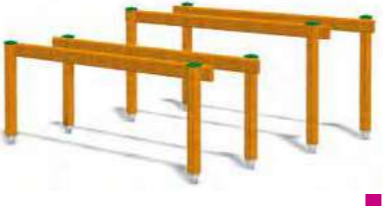

PLE0014



Stazione per lo stretching ed il potenziamento della muscolatura superiore

-  304x124x251h
-  m³ 0,35
-  2h
-  2
-  4x50x50x85h



PLE0015

Stazione di decontrazione e raffreddamento

-  400x62x51h
-  m³ 0,12
-  2x40x40x90h

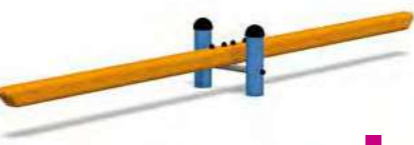

PLE0016

Stepper h60

Cartello esplicativo PLE0116

-  40x40x63h
-  m³ 0,10
-  0,15h
-  1
-  1x50x50x85h



PLE0017

Stazione per il potenziamento della muscolatura addominale

Cartello esplicativo PLE0117

-  225x79x103h
-  m³ 0,35
-  0,2h
-  2
-  4x50x50x85h



PLE0018

Stazione per il potenziamento della muscolatura delle braccia

Cartello esplicativo PLE0118

-  189x60x82,5h

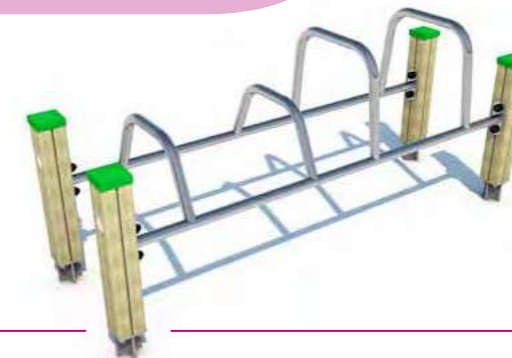

PLE0019

Stazione per il potenziamento della muscolatura inferiore

Cartello esplicativo PLE0119

-  225x79x103h



PLE0020

Stazione per la coordinazione acrobatica

Cartello esplicativo PLE0120

-  300x106x137h
-  m³ 0,35
-  0,12h
-  2
-  4x50x50x85h



Vedi anche: Jim 1 Jim 2 Jimmi 3 Jimmi 4 Jimmi 5 p. 170-172



active point

Scopri il tuo potenziale atletico

Buone pratiche per promuovere la salute della comunità e favorire l'interazione tra le persone

Un sistema vario di svago per esterni contribuisce al benessere della comunità fornendo un miglioramento della qualità della vita dei residenti favorendo anche l'interazione tra le persone. Degli spazi fitness per adulti ben studiati e innovativi possono servire un'ampia gamma di visitatori e contribuire alla salute della comunità; inoltre possono essere installati ovunque contribuendo così a ridurre questa barriera di accesso.

ACTIVE POINT è un insieme di attrezzature fitness per l'esterno concepito per utenti dai 13 anni in su e basato sulle ultimissime metodologie per la ginnastica

a corpo libero. 5 Stazioni con 120 esercizi e 3 livelli di abilità -principiante, intermedio, avanzato- consente di eseguire catene cinetiche che attivano tutti gli schemi di movimento principali.

ACTIVE POINT migliora il livello di forma fisica, permettendo all'intera comunità di ritrovarsi in un dinamico percorso fitness all'aria aperta. Totalmente privo di ingranaggi altrimenti vandalizzabili, **ACTIVE POINT** è ideale per gli spazi all'aperto in quelle situazioni in cui non è sempre possibile svolgere attività di manutenzione.

FBGY1001 Stretching e riscaldamento



295x186x272h

486x595

active point

FBGY1002

Flessioni, trazioni, ostacoli



498x440x232h

738x798

FBGY1003

Flessioni, equilibrio e squat



311x411x235h

611x558

FBGY1004

Agility e Power Step



221x94x262h

393x520

FBGY1005

Addominali e propriocettivo



273x79x260h

573x380



GymCane

aree all'aperto per cani e i loro compagni

GymCane

parchi per cani

Il marchio TLF® dal 1984 è impegnato nella progettazione, realizzazione e commercializzazione di aree ludiche all'aperto. Sappiamo che il sentimento provato per i cani è quello stesso che nutriamo per i bambini, allora... Perché non creare un parco giochi dedicato a loro?

Attrezzature dedicate agli utenti a quattro zampe e i loro compagni

I parchi per cani possono essere situati in una ampia varietà di scenari, ma devono costituire luoghi attraenti e divertenti per tutti gli utenti, per esercitarsi, socializzare e godersi la natura!

Un design accurato offre ai cani e i loro proprietari una serie di vantaggi. La scelta di recinzioni, superfici, piantumazioni, ombreggiature, panchine e giochi d'acqua appropriate, sono scelte essenziali che si tradurranno in un parco cinofilo di successo e piacevole per la comunità.

I nostri esperti hanno configurato tre aree standard sia per cani di grande o piccola taglia: percorso combinato, area piccola e area grande, in base alle esigenze specifiche del progetto da sviluppare.

Le aree di addestramento possono offrire ulteriori esperienze per migliorare il parco dei cani. Fornire attrezzature basate sull'agilità può essere un modo divertente per promuovere il comportamento attivo.

Includendo attività basate sull'agilità, amplieremo le sfide per i cani di diverse taglia e abilità. Le aree per cani devono essere una destinazione comunitaria che offrano l'opportunità di esercizio e interazione tra animali in un ambiente sicuro.

I disegni sono basati sull'Agility Dog e sono stati sviluppati per l'uso da parte dei cani di tutte le abilità e livelli di confidenza. Soprattutto gli attrezzi **GYMCANE** riuniscono persone e comunità costruendo luoghi attraenti e divertenti per gli animali domestici e le loro famiglie.

Offriamo una varietà di componenti di gioco basati sull'agilità e attrezzature per cani che promuovono comportamenti salutari come strisciare, saltare, scalare e altri aspetti psicomotori dell'animale.

Installazioni di arredo creano uno scenario idoneo per gli incontri e la socializzazione multi-generazionale.

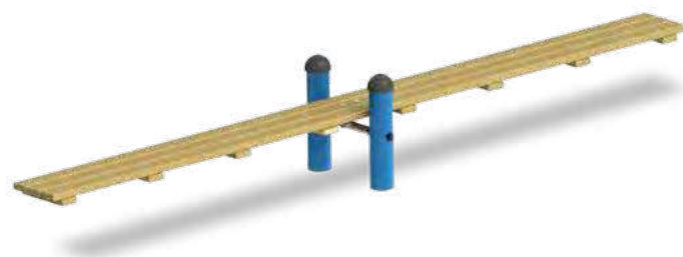

GYCE0001

Trave oscillante

400x57x56h

GYCE0002

Salto cerchio

117,5x11x125h

GYCE003

Percorso sopraelevato

474x627x67h

GYCE0004

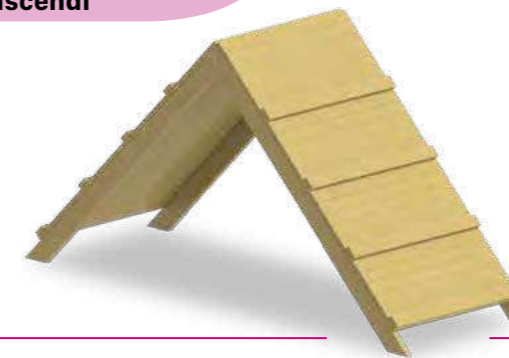
Saliscendi

364x120x185h

GYCE0005

Salto ostacoli

105,5x24,5x180h

GYCE0006

Rigatoni

80x194x79h

GYCE0007

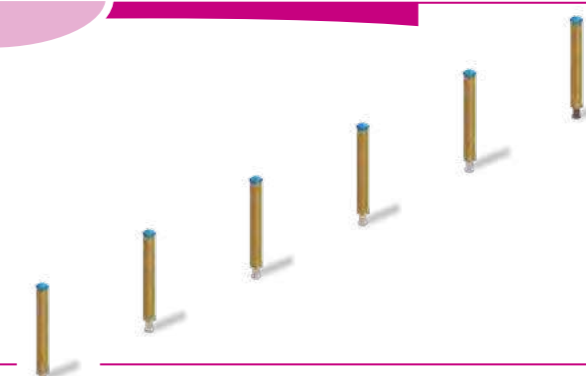
Sei ritti per slalom

760x10x110h

GYCE0008

Steppers

228x116x43h

Vedi anche: **Fontanella Cannella** pag 257. Per altri accessori consultare la sezione sugli spazi per tempo libero.



Ninfeo

vita all'aperto

La vita all'aria aperta riguarda primariamente la società, l'attività fisica, lo svago e la collettività. Le persone e le comunità che possono vantare buona qualità di vita all'aperto sono più sane e più felici. Per favorire e alimentare la vita all'aria aperta, **TLF** propone un'ampia gamma di elementi di arredo e attrezzature di supporto quali sedute, gazebo, strutture ombreggianti e di riparo, chioschi, rimesse. Cestini, cartelli, recinzioni e ponti, contribuiscono alla comodità e alla fruizione della vita all'aperto.

Vivere all'aria aperta: la gioia di godersi la vita

Noi della **TLF** siamo convinti che per essere in armonia con il paesaggio, tutto ciò che serve è la qualità, l'eleganza, la scelta dei materiali ed il design. Abbiamo fatto di questa convinzione il nostro punto di partenza per la realizzazione dei nostri progetti, che sono il risultato di una scrupolosa ricerca e una lunga esperienza nella lavorazione del legno.

Esistono comunque molti altri spazi che possiamo migliorare lavorando insieme. Il nostro lavoro è quello di aggiungere elementi naturali agli spazi urbani, migliorandoli con calore, eleganza ed un tocco di

fantasia. La produzione della **TLF** può soddisfare ogni esigenza di design, con una vasta gamma di soluzioni flessibili che si fondono adattandosi a qualunque concetto di città, nel rispetto delle più antiche tradizioni, pur rispondendo alle esigenze di atmosfere urbane più moderne e aggiornate. Diamo molta importanza all'immagine senza per questo togliere nulla alla sostanza.

Garantiamo affidabilità, convenienza e sicurezza insieme alla varietà e ampiezza di prodotti ogni volta che affrontiamo un programma di design urbano.



Le sedute sono un elemento essenziale per rendere confortevoli e accoglienti gli spazi pubblici all'aperto



Incontrarsi per giocare insieme, condividere un pasto e godersi la compagnia degli altri



Pergolati e gazebo offrono riparo, ombra, confort e posti d'incontro



Un'attenzione particolare alla cura dei dettagli e alle rifiniture contraddistingue la linea Ninfeo



Il legno utilizzato proviene da "filiera corta" e da foreste certificate per la loro virtuosa gestione





Elementi di arredo concepiti secondo le regole del più moderno design urbano, da collocare anche nelle realtà più piccole

3.102

Panchina Perugia



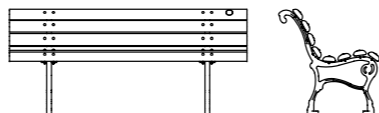

-  175x75x78h
-  m³ 0,06
-  4x 25x25x40h



3.106/A1

Panchina Tivoli



-  197x66x74h
-  m³ 0,06
-  4x 25x25x40h

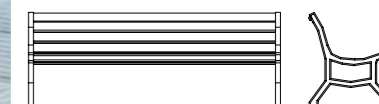

3.103/B



Panchina Firenze



In legno duro pregiato,
14 stecche

3.103

In pino, 14 stecche

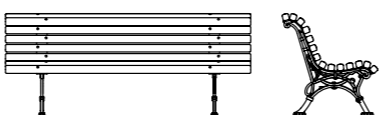

-  175x69x74h
-  m³ 0,06
-  4x 25x25x40h



3.107/A1

Panchina La Spezia



-  194x55x82h
-  m³ 0,06
-  4x 25x25x40h

3.107/B1

Panchina La Spezia L.140

-  140x55x82h

3.107/B2

Panchina La Spezia L.140
Senza spalliera

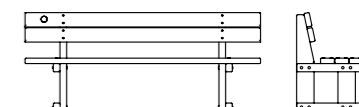

-  140x55x44h



3.104

Panchina Leone



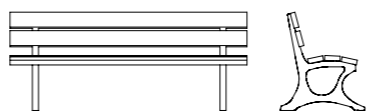

-  194x56x78h
-  m³ 0,06
-  4x 25x25x40h



3.108



Panchina Rieti



-  194x55x79h
-  m³ 0,06
-  4x 25x25x40h

3.108/B

Panchina Rieti L.140

-  140x55x79h
-  m³ 0,06
-  4x 25x25x40h



3.114

Panchina Andria



194x65x84h
m³ 0,06
4x 25x25x40h

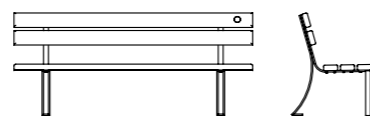

designer: Fabio Casadei

3.115

Panchina Isidora



194x61x80h
m³ 0,06
4x 25x25x40h

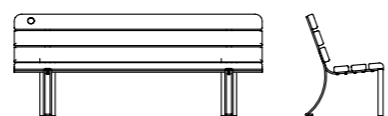

designer: Fabio Casadei

3.101

Panchina Antis



180x61x81h
m³ 0,09
4x 25x25x40h







3.116

Panchina Elba

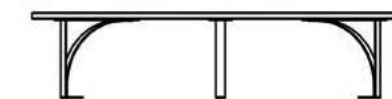

Ø200x45h
m³ 0,15
6x 25x25x40h



Vedi anche: **Benni**  p. 116 **Tortuga**  p. 73 **Tribuna**  p. 202 **Anfiteatro dei Popoli**  p. 112

Fioriera con 4 sedute  p. 255 **Composizione di 2 fioriere con seduta**  p. 255

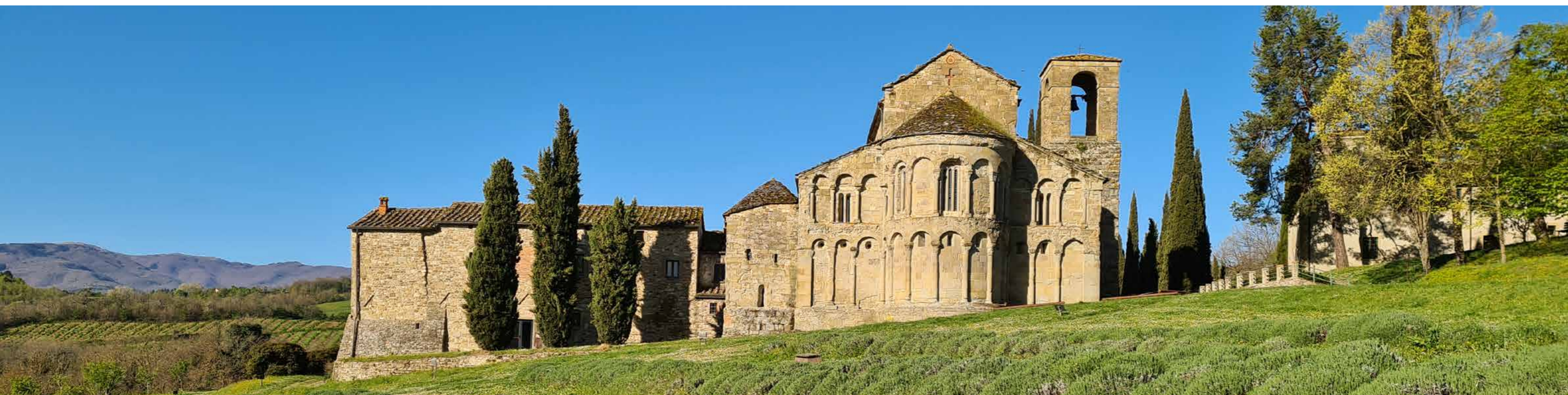

3.128/A10

Panchina Romena con braccioli

190x70x84h
m³ 0,06
4x 25x25x40h

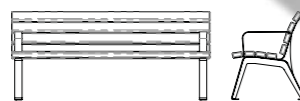

3.128/A20

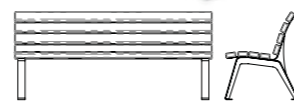
**Panchina Romena
Senza braccioli**

3.128/B10

Poltrona Romena con braccioli

70x70x84h
m³ 0,06
4x 25x25x40h

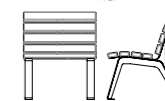

3.128/B20

**Poltrona Romena
Senza braccioli**

3.128/A30

Panca Romena con braccioli

190x61x65h
m³ 0,06
4x 25x25x40h



3.128/A40

**Panca Romena
Senza braccioli**

3.128/B30

Sgabello Romena con braccioli

70x61x65h
m³ 0,06
4x 25x25x40h



3.128/B40

**Sgabello Romena
Senza braccioli**

margherita

Uno spazio per ciascuno

I vibranti colori della gamma **Margherita** sono appositamente studiati per renderla accattivante, vivace, ma allo stesso tempo docile nella sua integrazione con lo spazio, l'architettura o il verde che la accolgono. Linee semplici e tradizionali, ma dal carattere innovativo, che rompono gli schemi rigorosi dell'arredo urbano: abbinare più colori nello stesso spazio.



SEDUTA MARGHERITA

Utilizzata in un contesto urbano, può trasformare una piazza cittadina in un elegante salotto



TAVOLO ASSO

Un comodo appoggio per giocare a carte, lavorare al computer o immergersi nella lettura, rilassarsi con gli amici e osservare i bambini che giocano.



TAVOLO MARGHERITA

Un tavolo spazioso, per feste all'aperto e picnic, per una riunione di lavoro nel verde e per un pomeriggio di ripasso in compagnia il giorno prima dell'esame



PANCHINA MARGHERITA

Un arredo urbano ben studiato favorisce gli incontri e la socializzazione. Una panchina comoda e colorata come scenario delle vostre conversazioni.



CESTINO MARGHERITA

Indispensabile per mantenere gli spazi pubblici puliti, se installato in più colori può essere utilizzato per la raccolta differenziata e per rendere più allegro l'ambiente.

NFIA1001ACCP

Panchina Margherita

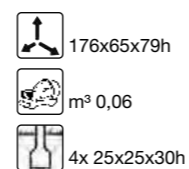
NFIA1001AZCP
NeutroNFIA1001ABCP
ArancioNFIA1001AGCP
VerdeNFIA1001ACCP
Blu

designer: Fabio Casadei

NFIA1002AGCP

Seduta Margherita

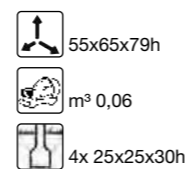
NFIA1002AZCP
NeutroNFIA1002ABCP
ArancioNFIA1002AGCP
VerdeNFIA1002ACCP
Blu

designer: Fabio Casadei

NFIB1001ABCP

Tavolo Margherita

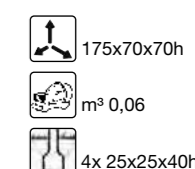
NFIB1001AZCP
NeutroNFIB1001ABCP
ArancioNFIB1001AGCP
VerdeNFIB1001ACCP
BluNFIB0901CZZS
Kit collegamento

designer: Fabio Casadei

NFIB1002AZCP

Tavolo Asso

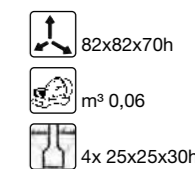
NFIB1002AZCP
NeutroNFIB1002ABCP
ArancioNFIB1002AGCP
VerdeNFIB1002ACCP
BluNFIB0902CZZS
Kit collegamento



designer: Fabio Casadei

Le varianti colori che offre la serie Margherita sono abbinabili tra di loro.

NFLA1001AZC

Panchina Olivia



-  175x61x77h
-  m³ 0,06
-  4x 25x25x40h





designer: Fabio Casadei

NFLA1002AZC

Seduta Olivia



-  175x33x41h
-  m³ 0,06
-  4x 25x25x40h

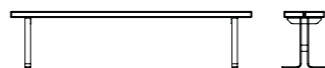



designer: Fabio Casadei

NFLA1003AZC

Poltrona Olivia



-  76x61x77h
-  m³ 0,06
-  4x 25x25x30h

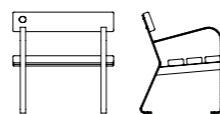



designer: Fabio Casadei

NFLB1001AZC

Pic-Nic Olivia



-  175x163x72h
-  m³ 0,06
-  4x 25x25x40h

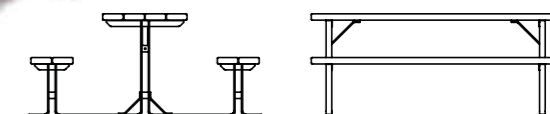

designer: Fabio Casadei

NFLB1002AZC

Pic-nic Olivia accessibile

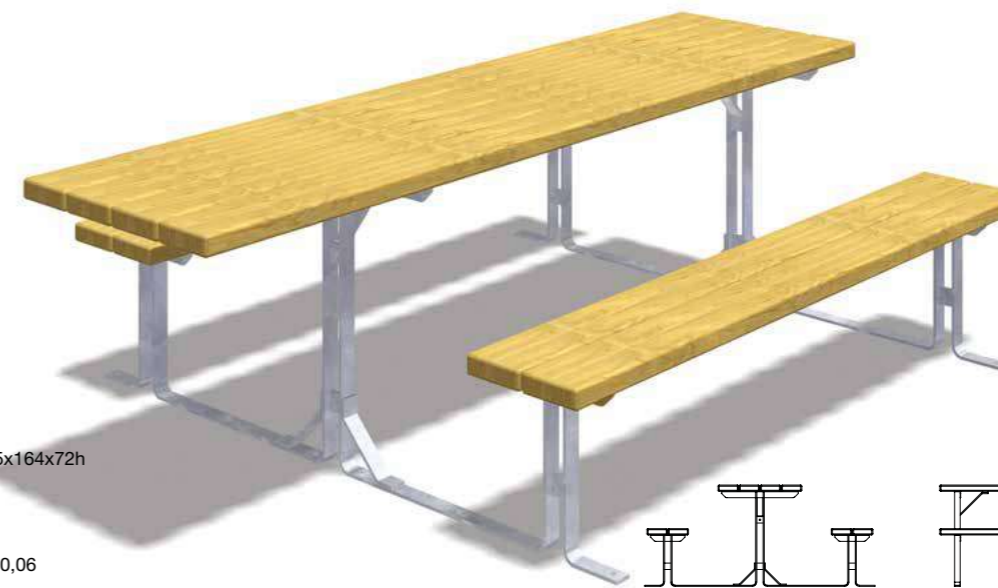

-  225x164x72h
-   m³ 0,06
-  4x 25x25x40h

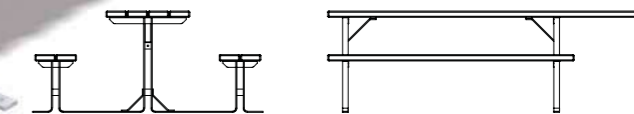

designer: Fabio Casadei

3.120/A

Pic-nic La Spezia



194x194x82h
m³ 0,06
4x 25x25x40h

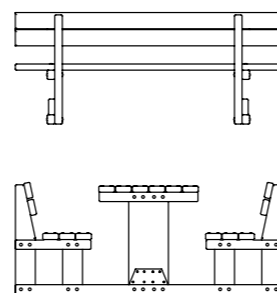

3.122

Pic-nic Vieste

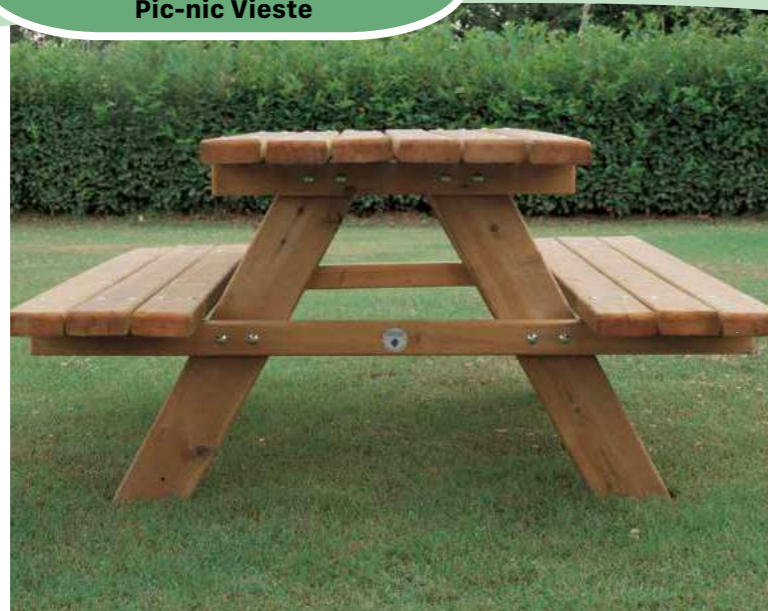

194x148x81h
m³ 0,06
4x 25x25x40h

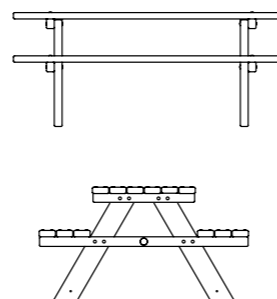

3.122/A

Pic-nic Vieste accessibile



235x145x81h
m³ 0,06
4x 25x25x35h

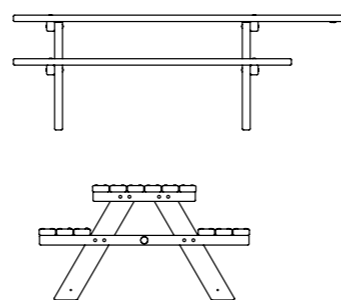

3.124

Pic-nic Andria



194x200x86h
m³ 0,06
4x 25x25x40h

3.124/A
Pic-nic Andria Accessibile

235x200x86h

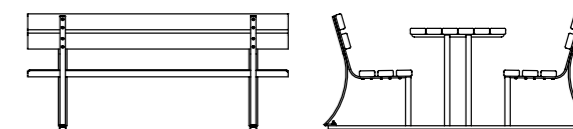

designer: Fabio Casadei

3.125

Pic-nic Isidora



194x193x82h
m³ 0,06
4x 25x25x40h

designer: Fabio Casadei

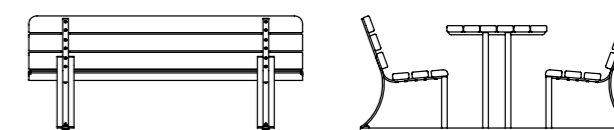

Vedi anche: Mindy  p. 116

3.201/A

Cestino Alassio

3.201/ASP
Cestino Alassio
cestino zincato
senza palo

 33xØ28x44h

Cestino zincato

 37xØ28x85

 m³ 0,01

 1x 25x25x30h

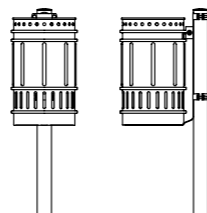

NFIC1001ACC

Cestino Margherita

designer: Fabio Casadei

NFIC1001AZCP
Neutro



NFIC1001ABCP
Arancio



NFIC1001AGCP
Verde



NFIC1001ACCP
Blu



 Ø34x83h

 m³ 0,01

 1x 25x25x40h

3.201/C

Cestino Alassio

Verniciato

 36xØ28x85h

 m³ 0,01

 1x 25x25x30h

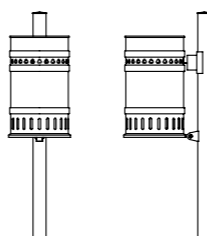

3.204/A

Cestino Isidora

Cestino arancione con
anello

 Ø35x83h

 m³ 0,01

 1x 25x25x30h



3.204/B
Cestino Isidora
cestino arancione
senza anello

 Ø35x83h

 m³ 0,01

 1x 25x25x30h

3.204/AG

Cestino Isidora
cestino giallo
con anello

 Ø35x83h

 m³ 0,01

 1x 25x25x30h

3.204/BG
Cestino Isidora
cestino giallo
senza anello

 Ø35x83h

 m³ 0,01

 1x 25x25x30h

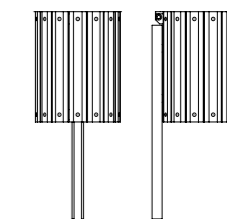

designer: Fabio Casadei

3.202

Cestino Vienna

3.202/SP
Cestino Vienna
cestino zincato e
verniciato senza palo

 35xØ30x78h

Cestino zincato
e verniciato

 46xØ30x108h

 m³ 0,01

 1x 25x25x30h

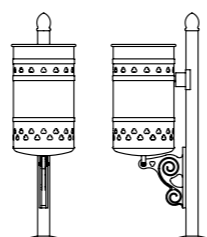

3.204/C

Cestino Isidora

Cestino arancione
con coperchio

 Ø35x100h

 m³ 0,01

 1x 25x25x30h



3.204/CG
Cestino Isidora
cestino giallo
con coperchio

 Ø35x100h

 m³ 0,01

 1x 25x25x30h

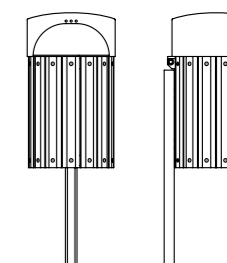

designer: Fabio Casadei

3.221

Cestone Andria

Cestino con anello



Ø55x89h



m³ 0,03

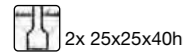

2x 25x25x40h



3.221/A

Cestone Andria
con base
autolivellante

70xØ55x101h

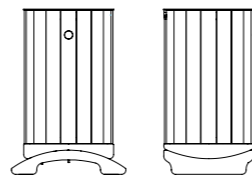

designer: Fabio Casadei

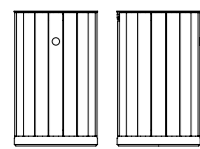

3.221/B

Cestone Andria con coperchio

Con coperchio



Ø54x113h



m³ 0,03

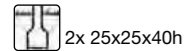

2x 25x25x40h

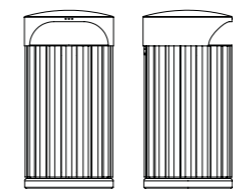

designer: Fabio Casadei

3.303/B

Fioriera quadrata

3.302/B



100x100x54h

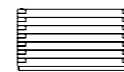

3.302/C



100x100x50h

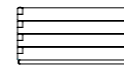

3.303/B



70x70x54h



3.303/C



70x70x50h



3.304/B



50x50x54h



3.304/C



50x50x50h



3.312/B

Fioriera rettangolare



100x50x54h

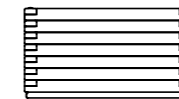

3.312/C



100x50x50h

3.313/B



140x70x54h

3.313/C



140x70x50h

140x70x50h

3.325/B

Fioriera con 4 sedute



200x200x68h

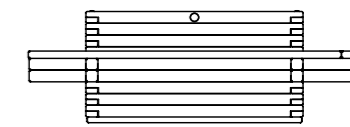

3.330/B

Composizione di 2 fioriere con seduta



334x70x54h





Vedi anche:

Ninetta Bonanza  p. 109Ortolina  p. 137

3.230

Portabiciclette 5 posti





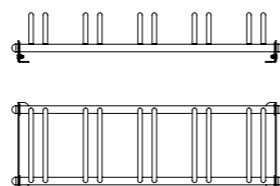

-  151x48x28h
-  m³ 0,06
-  4x 25x25x40h

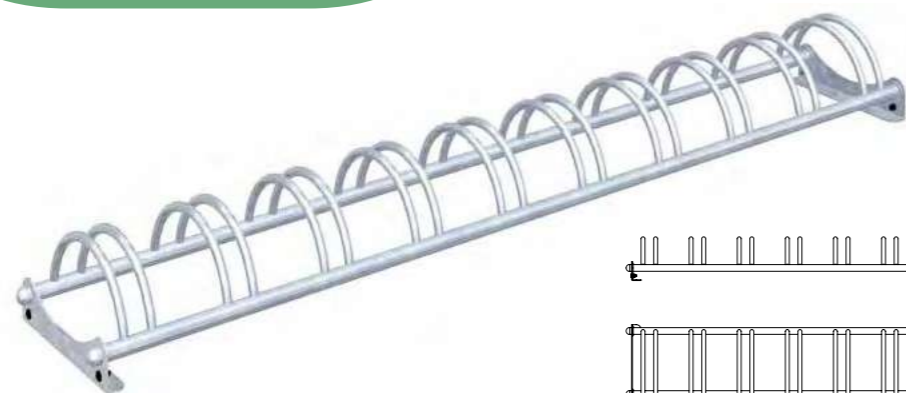

3.230/A

Portabiciclette 10 posti



-  304x48x28h
-  m³ 0,06
-  4x 25x25x40h

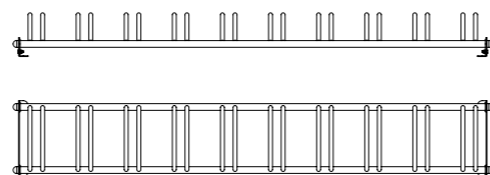

NFZG1001CHZS

Portabiciclette Archetto



Versione flangiata

Versione da interrare



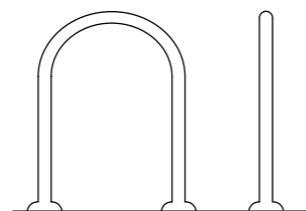

-  76,5x12x83h



3.381

Fontanella in legno



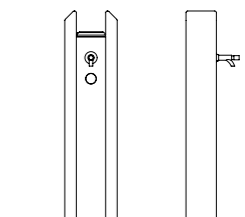

-  25x25x100h
-   m³ 0,04
-  1x 40x40x30h



NFIF1001CZCM

Fontanella Stilla



-  57x30x100h
-  m³ 0,01
-  1x25x25x40h

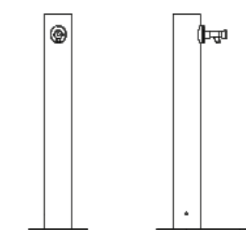

NFIF1002CZCM

Fontanella Cannella

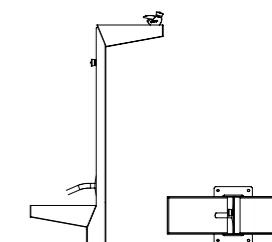

-  69x30x122h

Vedi anche:  Schizzo p. 139

3.901

Bacheca con tetto

3.901

Bacheca con tetto
pannello cm 100x140

186x43x221h

m³ 0,19

4x 40x40x60h

3.902

Bacheca con tetto
pannello cm 70x100

116x43x221h

m³ 0,19

4x 40x40x60h

3.903

Bacheca con tetto
pannello cm 100x70

146x43x221h

m³ 0,19

4x 40x40x60h

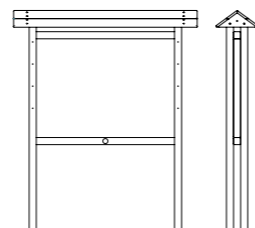

3.922

Bacheca semplice

99x7x210h

m³ 0,05

2x 25x25x50h

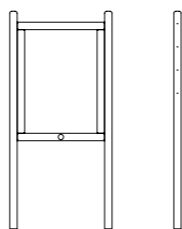

3.950

Freccia indicatoria con incisioni

80x11,5h

m³ 0,04

1x 40x40x60h

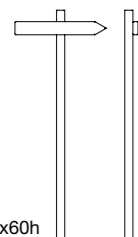

3.970

Cartello segnaleticoDisponibile con
palo in acciaio

40x60h



3.501/SP

Gazebo ottagonale

Senza pavimento

Ø500x330h

m³ 0,60

9h

4

8x 50x50x60h



3.501

Gazebo ottagonale
Con pavimento

Ø500x330h

m³ 0,60

10h

4

8x 50x50x60h

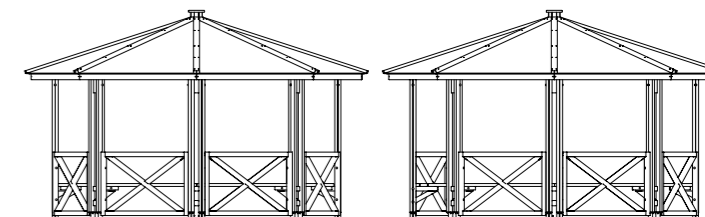

3.502/SP

Gazebo esagonale

Senza pavimento

479x415x286h

m³ 0,45

5h

4

6x 50x50x60h



3.502

Gazebo esagonale
con pavimento

479x415x286h

m³ 0,45

6h

4

6x 50x50x60h

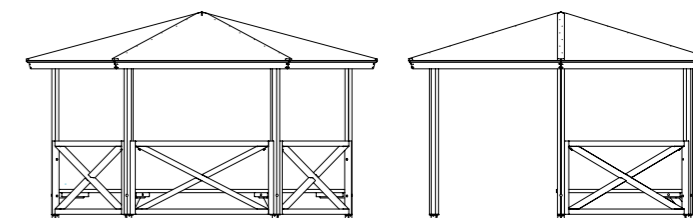



3.604N

Recinzione Valdarno

-  200x9,5x105h
-  m³ 0,04
-  0,5h
-  1
-  1x 40x40x40h





3.604NP
Palo terminale

-  9,5x9,5x105h
-  m³ 0,04
-  1x 40x40x40h



3.606N



Recinzione Savio

-  200x7x80h
-  m³ 0,02
-  0,5h
-  1
-  2x ø30x40h





3.607N

Recinzione Tirolo

-  250x12x85h
-  m³ 0,02
-  0,5h
-  1
-  1x ø30x40h

3.607NP
Palo terminale

-  10x10x107h
-  m³ 0,0187
-  1x50x50x85h





3.607N/A

Recinzione Tirolo A

-  250x12x85h
-  m³ 0,02
-  0,5h
-  1
-  1x ø30x40h

3.607N/AP
Palo terminale

-  10x10x107h
-  m³ 0,0187
-  1x50x50x85h





3.615N

Recinzione Matarò

-  200x13x98h
-  m³ 0,04
-  0,5h
-  1
-  1x 40x40x50h

3.615NP
Palo terminale

-  9,5x9,5x98h
-  m³ 0,04
-  1x 40x40x50h





3.612N

Recinzione Sieve



-  150x9,5x98h
-  m³ 0,04
-  0,5h
-  1
-  1x 40x40x40h



3.612NP
Palo terminale

-  9,5x9,5x98h
-  m³ 0,04
-  1x 40x40x40h





3.614N

Recinzione Valdorcja

-  150x12x85h
-  m³ 0,02
-  0,5h
-  1
-  1x ø30x40h

3.614NP
Palo terminale

-  10x10x107h
-  m³ 0,0187
-  1x50x50x85h





3.616N

Recinzione Seasons

-  17x168x107h
-  m³ 0,0187
-  0,5
-  2
-  1x50x50x85h

3.616NP
Palo terminale





-  10x10x107h
-  m³ 0,0187
-  1x50x50x85h



3.609N

Recinzione Camaldoli



-  250x12x94h
-  m³ 0,02
-  0,5h
-  1
-  1x ø30x40h

3.609NP





Palo terminale

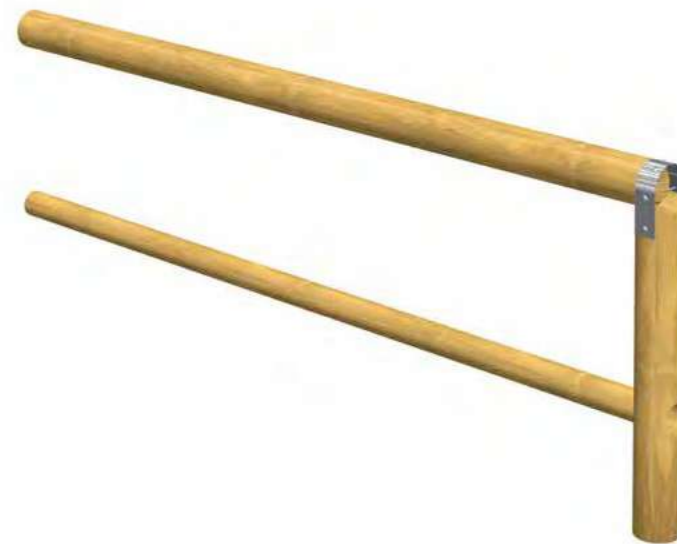

3.609N/A

Recinzione Camaldoli A



-  250x12x94h
-  m³ 0,02
-  0,5h
-  1
-  1x ø30x40h

3.609N/AP





Palo terminale

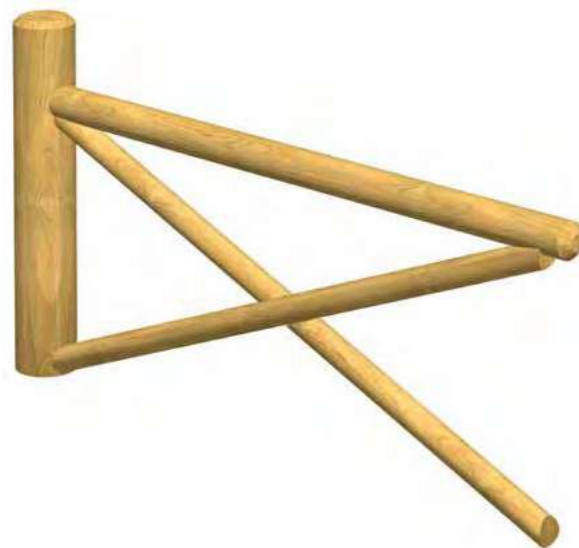

3.611N

Recinzione Pratomagno



-  150x12x85h
-  m³ 0,02
-  0,5h
-  1
-  1x ø30x40h

3.611NP

Palo terminale



3.702

Pavimento in legno



49x49x50h



3.703

Pavimento in legno



100x100x5h

Pavimentazione realizzata su misura



Rivolgetevi al Vostro Agente TLF per la realizzazione del vostro pavimento su misura.

1.801

Delimitazione area di sicurezza con assi legno

bordatura in legno



1.805

Delimitazione area di sicurezza cordolo

bordatura in legno, Ø140mm



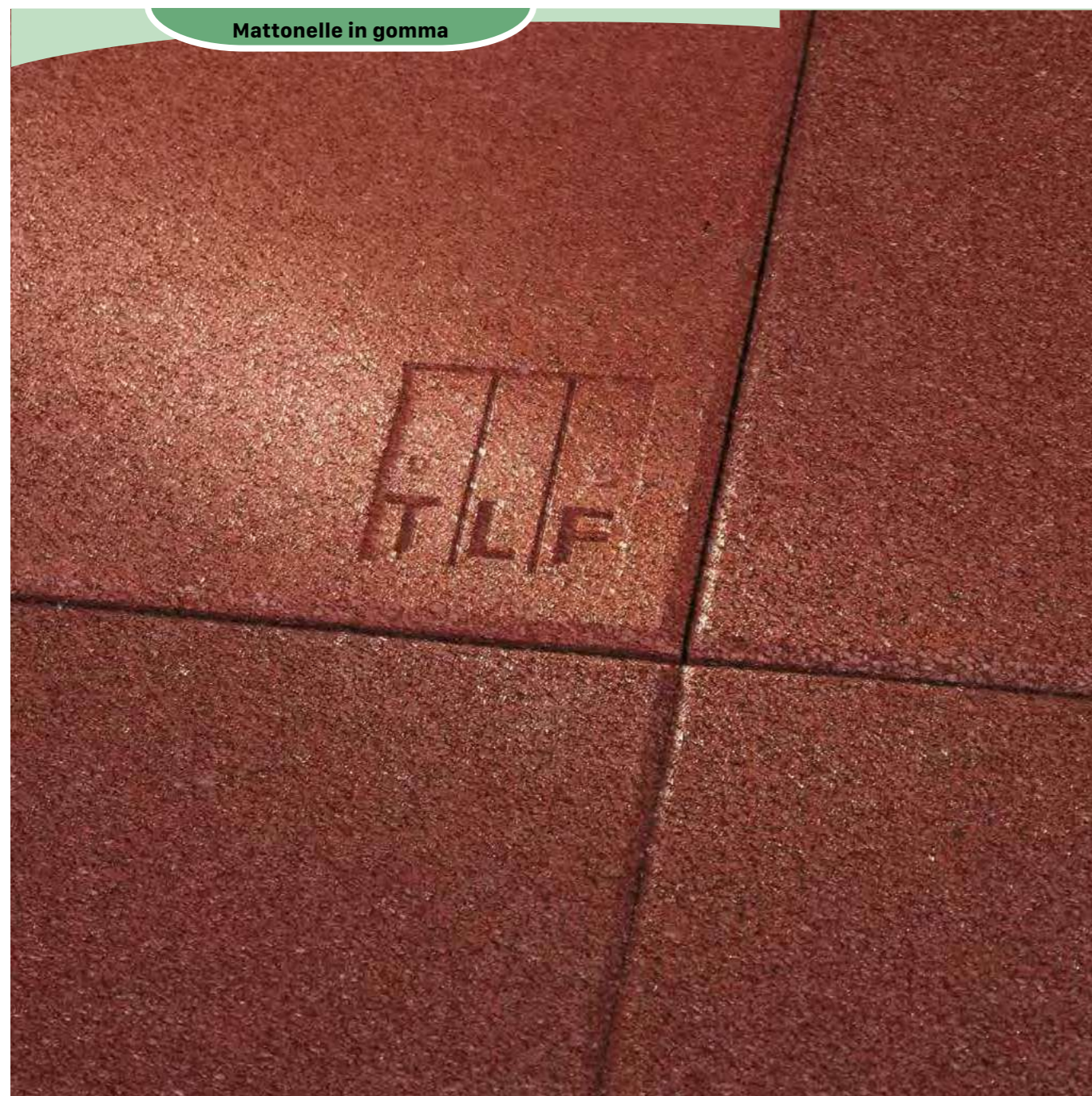

Mattonelle in gomma

CODICI	DESCRIZIONE	USO	MISURA	MASS. ALTEZZA DI CADUTA
1.870/SRI 1.870/SVI	Mattonella h 30	Mattonella piccola	50x50x3	1 m
1.872/SRI 1.872/SVI	Mattonella h 40	Mattonella piccola	50x50x4	1,40 m
1.872/BRI 1.872/BVI	Bordo smussato h 45	Bordo smussato laterale	50x50x4,5	1,50 m
1.872/CRI 1.872/CVI	Bordo smussato h 45	Bordo angolo aperto	50x50x4,5	1,50 m
1.872/DRI 1.872/DVI	Bordo smussato h 45	Bordo angolo chiuso	50x50x4,5	1,50 m
1.873/SRI 1.873/SVI	Mattonella h 45	Mattonella piccola	50x50x4,5	1,50 m
1.873/SRU	Mattonella h 45	Mattonella piccola	50x50x4,5	1,60 m
1.874/SRI 1.874/SVI	Mattonella h 50	Mattonella piccola	50x50x5	1,60 m
1.875/SRI 1.875/SVI	Mattonella h 55	Mattonella piccola	50x50x5,5	1,90 m
1.876/SRI 1.876/SVI	Mattonella h 70	Mattonella piccola	50x50x7	1,62 m
1.879/SRI 1.877/SVI	Mattonella h 80	Mattonella piccola	50x50x8	2,50 m
1.882/SRI 1.882/SVI	Mattonella h 90	Mattonella piccola	50x50x9	2,75 m

Caratteristiche tecniche indicative. TLF si riserva il diritto di modificare ogni prodotto ove sia necessario
I codici colorati segnalano la disponibilità di mattonelle colorate



Massima qualità e affidabilità

Le mattonelle in gomma garantiscono i più alti standard di sicurezza nei parchi giochi per consentire ai bambini di scatenarsi felicemente, senza rischio di farsi male. Le mattonelle in gomma sono ideali come pavimentazione per asili nido, scuole materne, cortili scolastici, strutture ricreative e centri di riabilitazione. Sono utilizzate sotto le attrezzature da ginnastica e arrampicata. La gamma comprende anche una serie di colori speciali.

Per creare delle superfici di gioco variegata e multidisciplinari sono disponibili dei particolari formati con lettere dell'alfabeto, con numeri e disegni, componibili tra di loro.

Colori speciali





Soft play

La pavimentazione colata in opera SOFT PLAY

Il sistema di pavimentazione colata in opera è un materiale continuo e poroso costituito da granuli di gomma e collanti a base poliuretanica. È mescolato ed installato sul posto. Lo strato di sottofondo è composto di granuli grezzi di gomma nera ottenuti dagli pneumatici dei camion riciclati; lo strato su-

periore di rifinitura, disponibile in molteplici colori, è costituito da granuli di gomma EPDM.

Il colato non richiede particolari interventi di manutenzione ed è altamente insonorizzante, caratteristica che la rende idonea per la realizzazione di parchi nei centri urbani oppure adiacenti ad abi-

tazioni, è facilmente lavabile con getto d'acqua a media pressione, ed è adatta a terreni piani, curvi e con pendenze fino a 45°. Grazie alla possibilità di accostare colori ed effetti, la pavimentazione è utile anche per segnalare aree del parco attrezzate per utilizzi differenti, come spazi ludici e spazi sportivi.

SOFT PLAY: la gamma

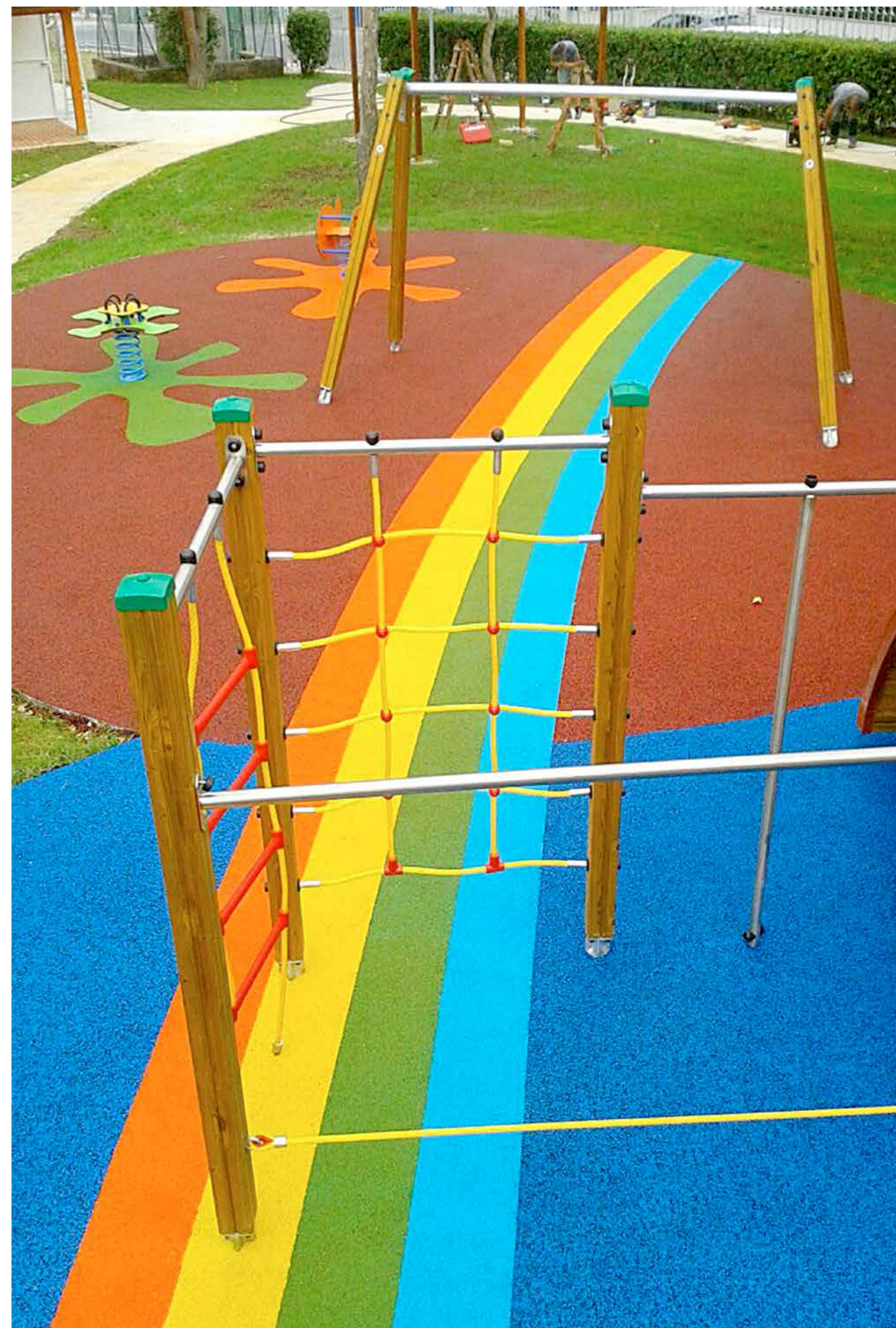



ALU habitat
ITALIAN URBAN DESIGN

la città è la casa di tutti

ALU habitat
ITALIAN URBAN DESIGN

arredare la città

Arredare la città è come arredare la casa. Le belle case sono quelle in cui passando da un ambiente all'altro si scoprono la personalità, il gusto, la cultura di chi le abita. Le belle case sono ancora più interessanti se qualcosa dell'architettura esterna, un decoro, un materiale, un colore, permea all'interno connotando con identità specifica lo spazio interno. Un arredo fatto di attrezzature concepite a misura di uomo, che sappiano comunicare un servizio, siano facili da usare e pensate "per tutti".

La collezione Sabauda

Creata per integrarsi a luoghi di diversa connotazione ed epoca, la collezione **Sabauda** comprende oggi una gamma di prodotti – gettarifiuti, seduta, portabiciclette, dissuasore e fioriera – destinata nel tempo ad ampliarsi nella direzione della flessibilità di collocazione e della integrazione al contesto.

Pensata per durare fisicamente e al cambiare delle mode, **Sabauda** adotta forme senza tempo e l'impiego di materiali nobili, ciò ne ha determinato una rapida diffusione in importanti città del mondo e ne ha determinato la scelta da parte di architetti famosi.

L'alluminio, durabile ed ecocompatibile, è anche il principale materiale della famiglia di arredi. Lavorato con

la tecnica della fusione che consente di ottenere forme ad alta resistenza, espressive e personalizzabili in massa con nomi, loghi e marchi, l'alluminio è il materiale in grado di connettere il passato con il futuro.

Le superfici si arricchiscono con modanature e rilievi per creare allo stesso tempo un segno distintivo della collezione e un deterrente al vandalismo, rendendo difficoltosi scritte e graffiti.

Disponibile in diverse finiture e colori adatti all'integrazione delle attrezzature in contesti storici, contemporanei, naturalistici, **Sabauda** è un concetto di arredo urbano a garanzia della durabilità e sostenibilità.



Le sedute sono un elemento essenziale per rendere confortevoli e accoglienti gli spazi pubblici all'aperto



La collezione Sabauda comprende una gamma di prodotti creata per integrarsi a luoghi di diversa epoca e connotazione

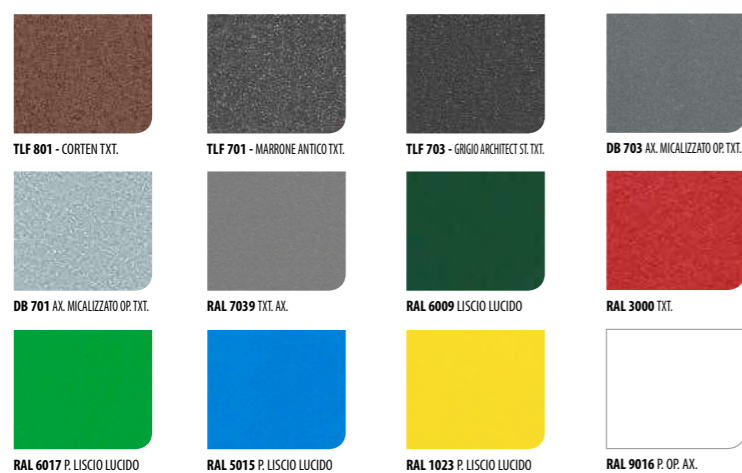

Disponibile in diverse forniture e colori adatti all'integrazione delle attrezzature in contesti contemporanei, storici o naturalistici

La scelta dell'alluminio è il punto di partenza per poter coniugare bellezza, sicurezza e solidità con un materiale 100% riciclabile

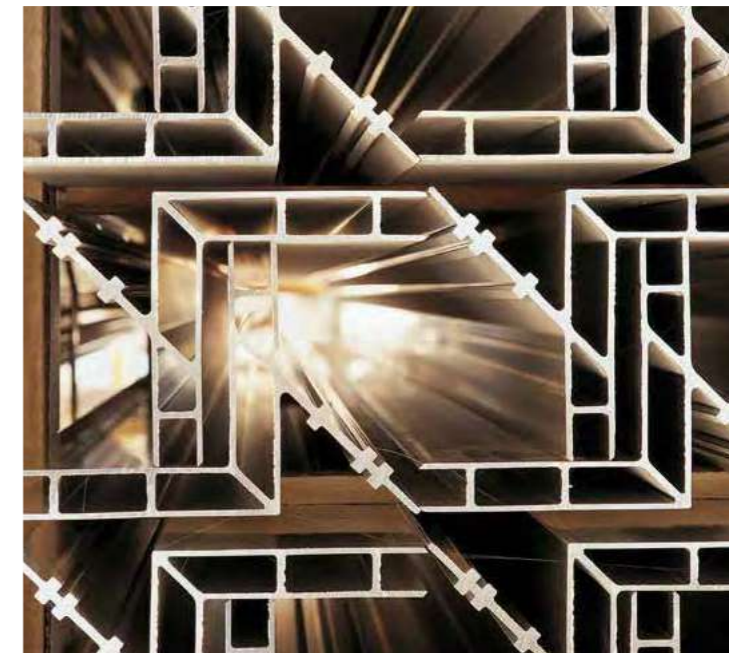

Le superfici si arricchiscono con modanature e rilievi come deterrente al vandalismo





Alla base di Aluhabitat c'è l'esperienza, l'inventiva, il segno riconoscibile di architetti e design di grande prestigio



100311

Panchina Sabaudo



-  216x72x89h
-  m³ 0,06
-  4x 25x25x40h

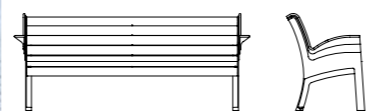

designer: Studio De Ferrari Architetti

100321

Panchina Sabaudo



- © Andrea Barghi
-  216x72x89h
-  m³ 0,06
-  4x 25x25x40h

Disponibile anche nella versione:

100331

Panchina Sabaudo
frassino termotrattato

designer: Studio De Ferrari Architetti

100411



Seduta Sabaudo



- © Andrea Barghi
- Disponibile anche nelle versioni:

100421

Poltrona Sabaudo
frassino color noce

-  87x72x89h
-  m³ 0,06
-  4x 25x25x40h

100431

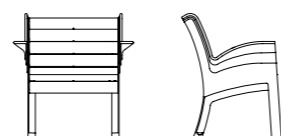

Poltrona Sabaudo
frassino termotrattato

designer: Studio De Ferrari Architetti

100600

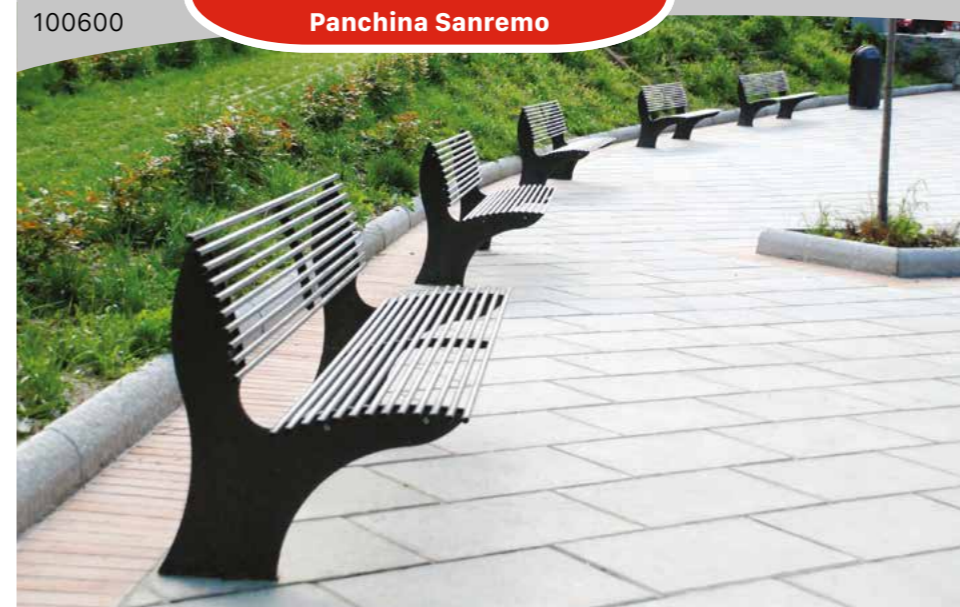
Panchina Sanremo



-  175x62x73h
-  m³ 0,12
-  8x 25x25x40h

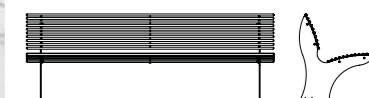



100500

Panchina Jesolo



in acciaio verniciato

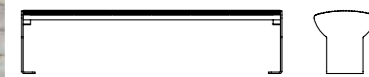

-  177x42x43h
-  m³ 0,06
-  4x 25x45x40h



1015031

Tavolo Pic-nic Jesolo accessibile



-  177x160x75h
-  m³ 0,06
-  4x 25x25x40h



Disponibile anche nelle versioni:

101500

Tavolo Pic-nic Jesolo
telaio portante in acciaio verniciato

101503

Tavolo Pic-nic Jesolo
con piano in HPL

-  176x64x82h
-  m³ 0,06
-  4x 25x25x40h

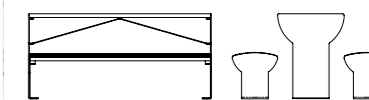

designer: Remo Zanchetta

200111

Cestone Sabauda 110 lt



© Andrea Barghi

Cestone portarifiuti personalizzabile con loghi e colori diversi

Disponibile anche nella versione:

200114

Cestone Sabauda 110LT per raccolta differenziata con due contenitori interni in polietilene da 30LT

53x50x101h

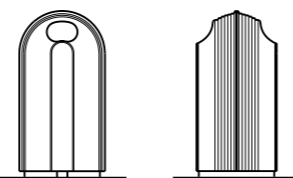

200115

Cestone Sabauda 55lt

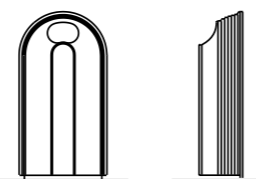

Prodotto disponibile con contenitore in polietilene e per la raccolta differenziata, i colori si possono personalizzare su indicazione del cliente.

53x28x101h

designer: Studio De Ferrari Architetti

Il cestone Sabauda è l'unico portarifiuti che può essere completamente rigenerato

Per **RIDURRE** il consumo di materie prime

Per **RIUTILIZZARE** i manufatti contribuendo alla loro sostenibilità nel tempo

Per **RECUPERARE** al ciclo produttivo tutte le componenti usurate attraverso un corretto processo di rigenerazione

VANTAGGI

- Mantenere nel tempo l'efficienza e la funzionalità del manufatto.
- Utilizzare e riutilizzare più volte gli stessi materiali
- Contribuire alla transizione verso un'economia efficiente nell'uso delle risorse, a basse emissioni di carbonio e resiliente ai cambiamenti climatici per raggiungere una crescita sostenibile.

- Puntare sull'economia circolare stimolando la creatività in funzione della valorizzazione economica del riuso di materiali e manufatti.
- Ottenere importanti benefici per l'ambiente e per la società.
- Contenere significativamente i costi specifici e generali.

200117

Kit posacenere



© Andrea Barghi

designer: Studio De Ferrari Architetti

200125

Contenitore in polietilene



Disponibile anche nella versione:

200126

Contenitore in polietilene per Sabauda 55LT

 65xØ44cm
capacità 30LT

designer: Studio De Ferrari Architetti

200122

Antibomba da 110LT



50x15

designer: Studio De Ferrari Architetti

200127



Chiave per cestone



designer: Studio De Ferrari Architetti

300501

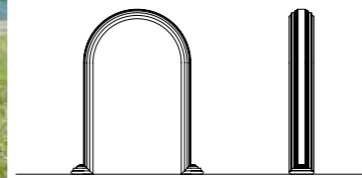
Portabiciclette / Dissuasore Sabaudo Arco

 52x12x80h

designer: Studio De Ferrari Architetti





301011

Portabiciclette Viareggio 5 posti

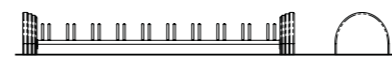

Disponibile anche nella versione:

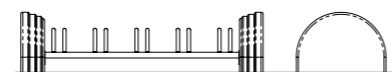
301111

Portabiciclette 10 posti con
basi in cemento
 331x66x45h

 178x66x45h

400101

Fioriera Sabaudo



In tubolare di acciaio inox

 Ø82x58h

Grazie.



Le caratteristiche tecniche, descrizioni, colori e altro sono da ritenersi puramente indicative.

Le dimensioni dell'attrezzatura in questo catalogo sono soggette a variazioni di $\pm 5\%$ rispetto a quelle indicate.

TLF si riserva il diritto di modificare ogni prodotto laddove sia necessario per migliorarne la qualità sia dal punto di vista delle dimensioni che della struttura.

© copyright TLF® 2023

È vietata la riproduzione anche parziale del presente catalogo.



TLF s.r.l.

Sede legale

Via Bergamo, 43
00198 Roma (RM)

Sede operativa

Via del Molino, 42 - Corsalone
52010 Chiusi della Verna (AR)
T. 0575 531 400
info@tlf.it
www.tlf.it

